

SN54ALS677A, SN54ALS678, SN74ALS677A, SN74ALS678 16-BIT ADDRESS COMPARATORS

D2661, JUNE 1982—REVISED MAY 1986

- 'ALS677A is a 16-bit Address Comparator with Enable
- 'ALS678 is a 16-bit Address Comparator with Latch
- Package Options Include Plastic "Small Outline" Packages, Ceramic Chip Carriers, and Standard Plastic and Ceramic 300-mil DIPs
- Dependable Texas Instruments Quality and Reliability

description

The 'ALS677A and 'ALS678 address comparators simplify addressing of memory boards and/or other peripheral devices. The four P inputs are normally hard wired with a preprogrammed address. An internal decoder determines what input information applied to the 16 A inputs must be low or high to cause a low state at the output (Y). For example, a positive-logic bit combination of 0111 (decimal 7) at the P input determines that inputs A1 through A7 must be low and that inputs A8 through A16 must be high to cause the output to go low. Equality of the address applied at the A inputs to the preprogrammed address is indicated by the output being low.

The 'ALS677A features an enable input (\bar{G}). When \bar{G} is low, the device is enabled. When \bar{G} is high, the device is disabled and the output is high regardless of the A and P inputs. The 'ALS678 features a transparent latch and a latch enable input (C). When C is high, the device is in the transparent mode. When C is low, the previous logic state of Y is latched.

The SN54ALS677A and SN54ALS678 are characterized for operation over the full military temperature range of -55°C to 125°C . The SN74ALS677A and SN74ALS678 are characterized for operation from 0°C to 70°C .

SN54ALS677A . . . JT PACKAGE
SN74ALS677A . . . DW OR NT PACKAGE

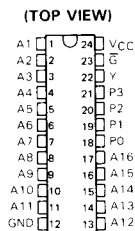

SN54ALS677A . . . FK PACKAGE
SN74ALS677A . . . FN PACKAGE

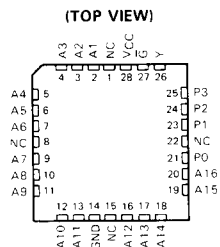

SN54ALS678 . . . JT PACKAGE
SN74ALS678 . . . DW OR NT PACKAGE

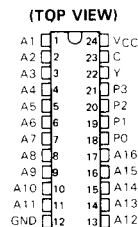

SN54ALS678 . . . FK PACKAGE
SN74ALS678 . . . FN PACKAGE

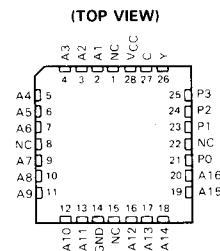

NC No internal connection

PRODUCTION DATA documents contain information current as of publication date. Products conform to specifications per the terms of Texas Instruments standard warranty. Production processing does not necessarily include testing of all parameters.

**TEXAS
INSTRUMENTS**

POST OFFICE BOX 655012 • DALLAS, TEXAS 75265

Copyright © 1982, Texas Instruments Incorporated

2-567

2
ALS and AS Circuits

SN54ALS677A, SN74ALS677A
16-BIT ADDRESS COMPARATORS

'ALS677A logic symbol†

'ALS677A logic diagram (positive logic)

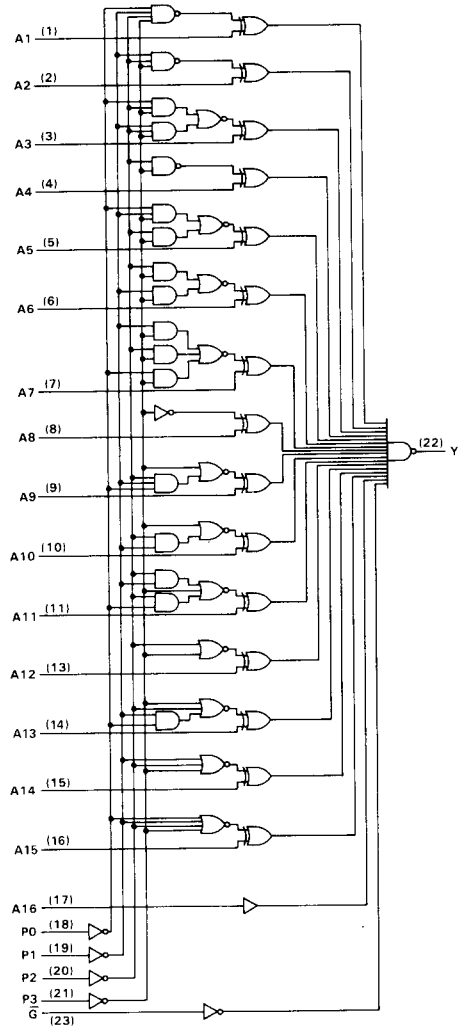
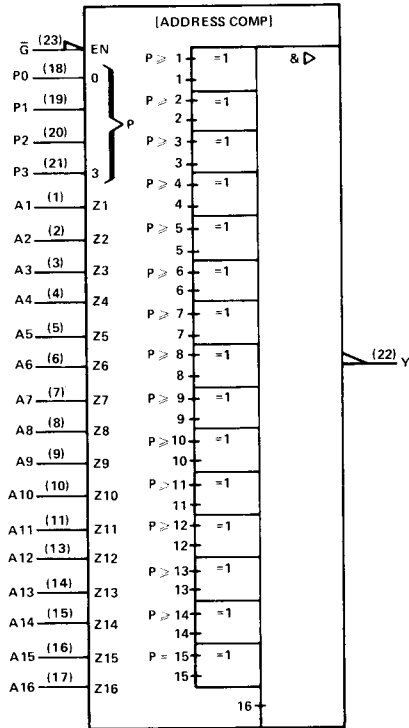

†This symbol is in accordance with ANSI/IEEE Std 91-1984 and IEC Publication 617-12. Pin numbers shown are for DW, JT, and NT packages.

SN54ALS678, SN74ALS678 16-BIT ADDRESS COMPARATORS

'ALS678 logic symbol[†]

'ALS678 logic diagram (positive logic)

2

ALS and AS Circuits

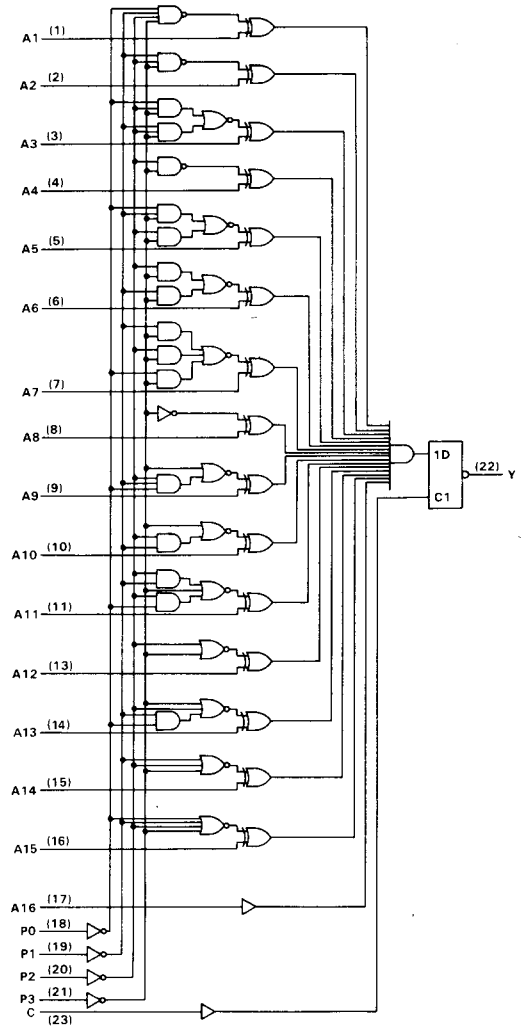
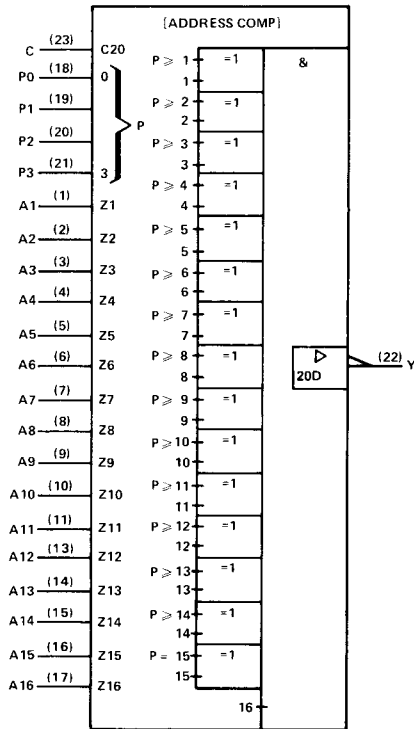

[†]This symbol is in accordance with ANSI/IEEE STD 91-1984 and IEC Publication 617-12. Pin numbers shown are for DW, JT, and NT packages.

SN54ALS677A, SN54ALS678, SN74ALS677A, SN74ALS678

16-BIT ADDRESS COMPARATORS

absolute maximum ratings over operating free-air temperature range (unless otherwise noted)

Supply voltage, V_{CC}	7 V
Input voltage	7 V
Operating free-air temperature range: SN54ALS677A, SN54ALS678	-55 °C to 125 °C
SN74ALS677A, SN74ALS678	0 °C to 70 °C
Storage temperature range	-65 °C to 150 °C

recommended operating conditions

	SN54ALS677A SN54ALS678			SN74ALS677A SN74ALS678			UNIT
	MIN	NOM	MAX	MIN	NOM	MAX	
V_{CC} Supply voltage	4.5	5	5.5	4.5	5	5.5	V
V_{IH} High-level input voltage	2			2			V
V_{IL} Low-level input voltage				0.8			V
I_{OH} High-level output current				-1			mA
I_{OL} Low-level output current				12			mA
t_w Pulse duration, enable C high	'ALS678			45			ns
t_{su} Setup time, data before C↓	'ALS678			50			ns
t_h Hold time, data after C↓	'ALS678			10			ns
T_A Operating free-air temperature				-55 125			°C

electrical characteristics over recommended operating free-air temperature range (unless otherwise noted)

PARAMETER	TEST CONDITIONS	SN54ALS677A SN54ALS678			SN74ALS677A SN74ALS678			UNIT
		MIN	TYP†	MAX	MIN	TYP†	MAX	
V_{IK}	$V_{CC} = 4.5 \text{ V}$, $I_I = -18 \text{ mA}$	-1.2			-1.2			V
V_{OH}	$V_{CC} = 4.5 \text{ V to } 5.5 \text{ V}$, $I_{OH} = -0.4 \text{ mA}$	$V_{CC}-2$			$V_{CC}-2$			V
	$V_{CC} = 4.5 \text{ V}$, $I_{OH} = -1 \text{ mA}$	2.4 3.3						
	$V_{CC} = 4.5 \text{ V}$, $I_{OH} = -2.6 \text{ mA}$				2.4 3.2			
V_{OL}	$V_{CC} = 4.5 \text{ V}$, $I_{OL} = 12 \text{ mA}$	0.25 0.4			0.25 0.4			V
	$V_{CC} = 4.5 \text{ V}$, $I_{OL} = 24 \text{ mA}$				0.35 0.5			
I_I	$V_{CC} = 5.5 \text{ V}$, $V_I = 7 \text{ V}$	0.1			0.1			mA
I_{IH}	$V_{CC} = 5.5 \text{ V}$, $V_I = 2.7 \text{ V}$	20			20			μA
I_{IL}	$V_{CC} = 5.5 \text{ V}$, $V_I = 0.4 \text{ V}$	-0.1			-0.1			mA
I_{O}^{\ddagger}	$V_{CC} = 5.5 \text{ V}$, $V_O = 2.25 \text{ V}$	-30 -112			-30 -112			mA
I_{CC}	$V_{CC} = 5.5 \text{ V}$	'ALS677A			'ALS677A			mA
		'ALS678			'ALS678			

† All typical values are at $V_{CC} = 5 \text{ V}$, $T_A = 25 \text{ °C}$.

‡ The output conditions have been chosen to produce a current that closely approximates one half of the true short-circuit output current, I_{OS} .

SN54ALS677A, SN54ALS678, SN74ALS677A, SN74ALS678
16-BIT ADDRESS COMPARATORS

'ALS677A switching characteristics (see Note 1)

PARAMETER	FROM (INPUT)	TO (OUTPUT)	V _{CC} = 5 V, C _L = 50 pF, R _L = 500 Ω, T _A = 25°C			V _{CC} = 4.5 V to 5.5 V, C _L = 50 pF, R _L = 500 Ω, T _A = MIN to MAX			UNIT	
			'ALS677A			SN54ALS677A		SN74ALS677A		
			MIN	TYP	MAX	MIN	MAX	MIN		MAX
t _{PLH}	Any P	Y	11	18	4	28	4	25	ns	
t _{PHL}			22	32	8	43	8	38		
t _{PLH}	Any A	Y	10	17	5	26	5	22	ns	
t _{PHL}			16	25	5	35	5	30		
t _{PLH}	\bar{G}	Y	6	10	3	15	3	13	ns	
t _{PHL}			16	30	5	40	5	35		

2

ALS and AS Circuits

'ALS678 switching characteristics (see Note 1)

PARAMETER	FROM (INPUT)	TO (OUTPUT)	V _{CC} = 4.5 V to 5.5 V, C _L = 50 pF, R _L = 500 Ω, T _A = MIN to MAX				UNIT
			SN54ALS678		SN74ALS678		
			MIN	MAX	MIN	MAX	
t _{PLH}	Any P	Y	6	27	6	22	ns
t _{PHL}			10	52	10	43	
t _{PLH}	Any A	Y	5	25	5	21	ns
t _{PHL}			5	40	5	35	
t _{PLH}	C	Y	3	25	3	20	ns
t _{PHL}			15	54	15	48	

NOTE 1: Load circuit and voltage waveforms are shown in Section 1.

TYPICAL APPLICATION INFORMATION

The 'ALS677A and 'ALS678 can be wired to recognize any one of 2¹⁶ addresses. The number of "lows" in the address determines the input pattern for the P inputs. Then those system address lines that are low in the address to be recognized are connected to the lowest numbered A inputs of the address comparator and the system address lines that are high are connected to the highest numbered A inputs.

For example, assume the comparator is to enable a device when the 16-bit system address is:

A15	A14	A13	A12	A11	A10	A9	A8	A7	A6	A5	A4	A3	A2	A1	A0
H	H	L	L	H	H	L	L	H	H	L	L	H	H	H	H

Since the address contains 6 lows and 10 highs, the following connections are made:

P3 to 0 V, P2 to VCC, P1 to VCC, and P0 to 0 V.

System address lines A13, A12, A9, A8, A5, and A4 to comparator inputs A1 through A6 in any convenient order.

The remaining ten system address lines to comparator inputs A7 through A16 in any convenient order.

The output provides an active-low enabling signal.

The following circuit is a modulo-N synchronous counter. The 'ALS163 is connected to provide a low-level clear signal when N = FEFF16.

