

# Quad timer

# NE558

## DESCRIPTION

The 558 Quad Timers are monolithic timing devices which can be used to produce four independent timing functions. The 558 output sinks current. These highly stable, general purpose controllers can be used in a monostable mode to produce accurate time delays; from microseconds to hours. In the time delay mode of operation, the time is precisely controlled by one external resistor and one capacitor. A stable operation can be achieved by using two of the four timer sections.

The four timer sections in the 558 are edge-triggered; therefore, when connected in tandem for sequential timing applications, no coupling capacitors are required. Output current capability of 100mA is provided in both devices.

## FEATURES

- 100mA output current per section
- Edge-triggered (no coupling capacitor)
- Output independent of trigger conditions
- Wide supply voltage range 4.5V to 16V
- Timer intervals from microseconds to hours
- Time period equals RC
- Military qualifications pending

## APPLICATIONS

- Sequential timing
- Time delay generation
- Precision timing
- Industrial controls
- Quad one-shot

## ORDERING INFORMATION

DESCRIPTION	TEMPERATURE RANGE	ORDER CODE	DWG #
16-Pin Plastic Small Outline Large (SOL) Package	0 to +70°C	NE558D	0171B
16-Pin Plastic Dual In-Line Package (DIP)	0 to +70°C	NE558N	0406C

## ABSOLUTE MAXIMUM RATINGS

SYMBOL	PARAMETER	RATING	UNIT
V <sub>CC</sub>	Supply voltage	+16	V
P <sub>D</sub>	Maximum power dissipation T <sub>A</sub> =25°C ambient (still-air) <sup>1</sup>		
	N package	1450	mW
	D package	1090	mW
T <sub>A</sub>	Operating ambient temperature range	0 to +70	°C
T <sub>STG</sub>	Storage temperature range	-65 to +150	°C
T <sub>SOLD</sub>	Lead soldering temperature (10sec max)	+300	°C

### NOTES:

- Derate above 25°C, at the following rates:  
 N package at 11.6mW/°C  
 D package at 8.7mW/°C

## PIN CONFIGURATION

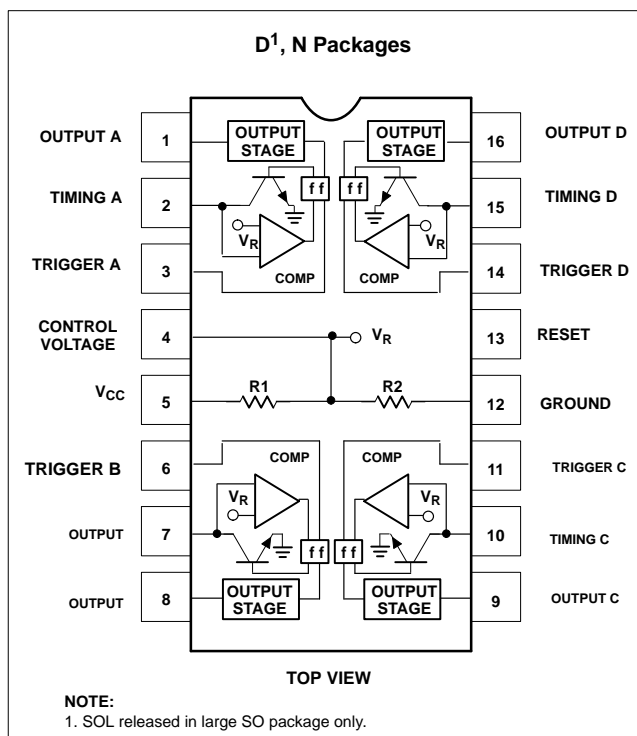

## Quad timer

## NE558

**DC AND AC ELECTRICAL CHARACTERISTICS**

$T_A = 25^\circ\text{C}$ ,  $V_{CC} = +5\text{V}$  to  $+15\text{V}$ , unless otherwise specified.

SYMBOL	PARAMETER	TEST CONDITIONS	NE558			UNIT
			Min	Typ	Max	
$V_{CC}$	Supply voltage		4.5		16	V
$I_{CC}$	Supply current	$V_{CC}=\text{Reset}=15\text{V}$		16	36	mA
$t_A$	Timing accuracy ( $t=RC$ )	$R=2\text{k}\Omega$ to $100\text{k}\Omega$ , $C=1\mu\text{F}$				
	Initial accuracy			$\pm 2$	5	%
$\Delta t_A/\Delta T$	Drift with temperature			30	150	ppm/ $^\circ\text{C}$
$\Delta t_A/\Delta V_S$	Drift with supply voltage			0.1	0.9	%/V
$V_{TRIG}$	Trigger voltage <sup>1</sup>	$V_{CC}=15\text{V}$	0.8		2.4	V
$I_{TRIG}$	Trigger current	Trigger=0V		5	100	$\mu\text{A}$
$V_{RESET}$	Reset voltage <sup>2</sup>		0.8		2.4	V
$I_{RESET}$	Reset current	Reset		50	500	$\mu\text{A}$
$V_{TH}$	Threshold voltage			0.63		$\times V_{CC}$
	Threshold leakage			15		nA
$V_{OUT}$	Output voltage <sup>3</sup>	$I_L=10\text{mA}$		0.1	0.4	V
		$I_L=100\text{mA}$		1.0	2.0	V
	Output leakage			10	500	nA
$t_{PD}$	Propagation delay			1.0		$\mu\text{s}$
$t_R$	Rise time of output	$I_L=100\text{mA}$		100		ns
$t_F$	Fall time of output	$I_L=100\text{mA}$		100		ns

**NOTES:**

1. The trigger functions only on the falling edge of the trigger pulse only after previously being high. After reset, the trigger must be brought high and then low to implement triggering.
2. For reset below 0.8V, outputs set low and trigger inhibited. For reset above 2.4V, trigger enabled.
3. The 558 output structure is open-collector which requires a pull-up resistor to  $V_{CC}$  to sink current. The output is normally low sinking current.

# Quad timer

# NE558

## 558 EQUIVALENT CIRCUIT

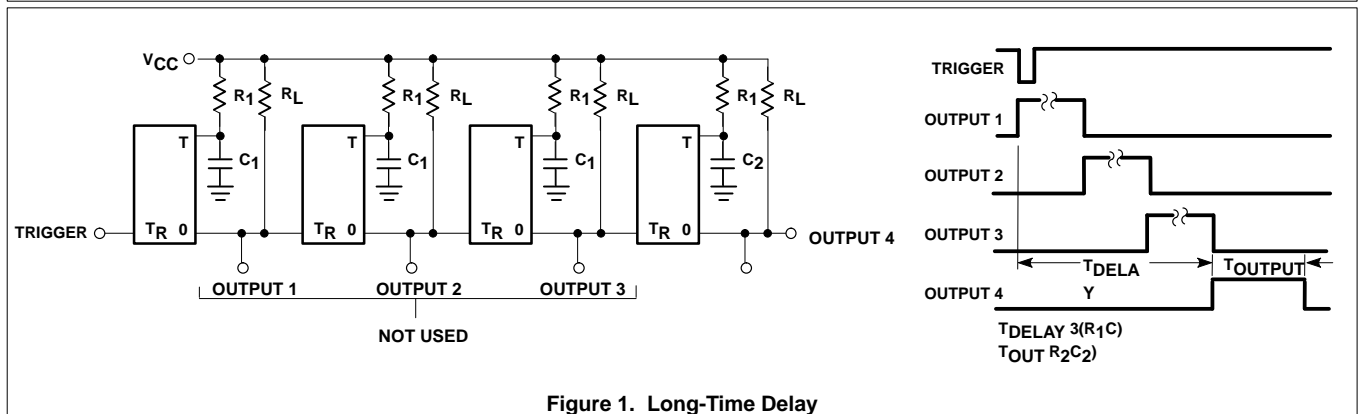
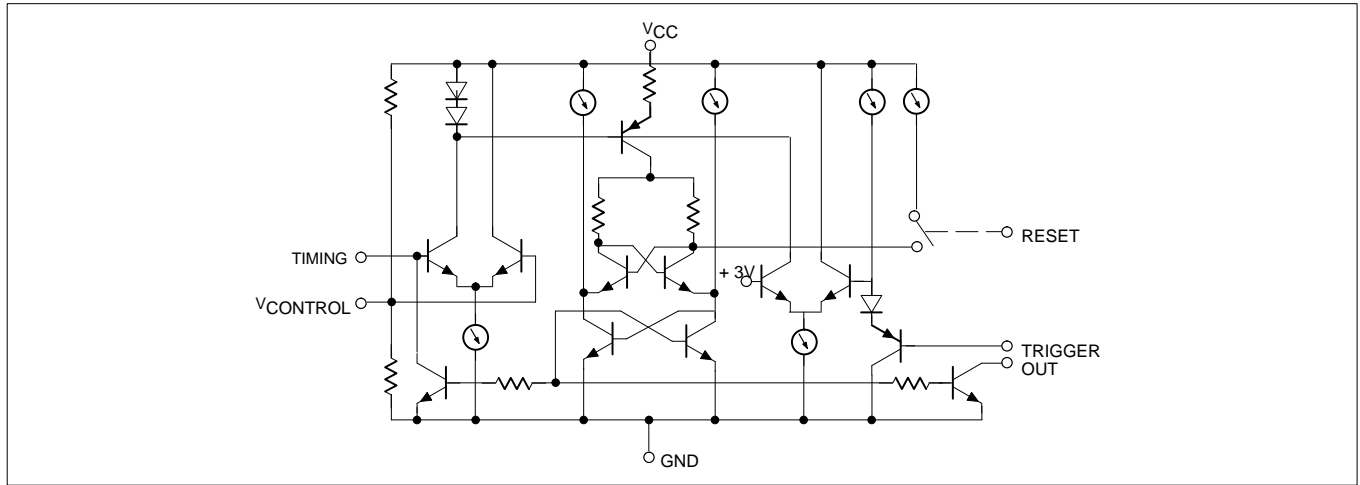
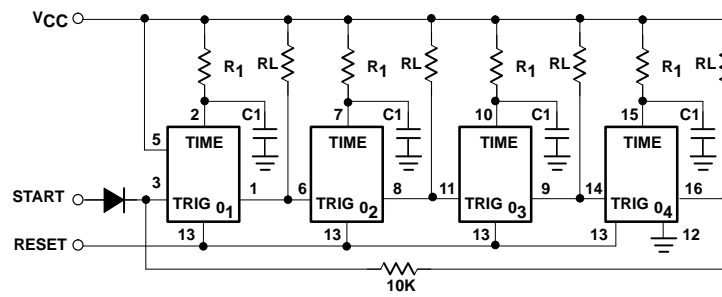

Figure 1. Long-Time Delay

Quad timer

NE555



a. Ring Counter

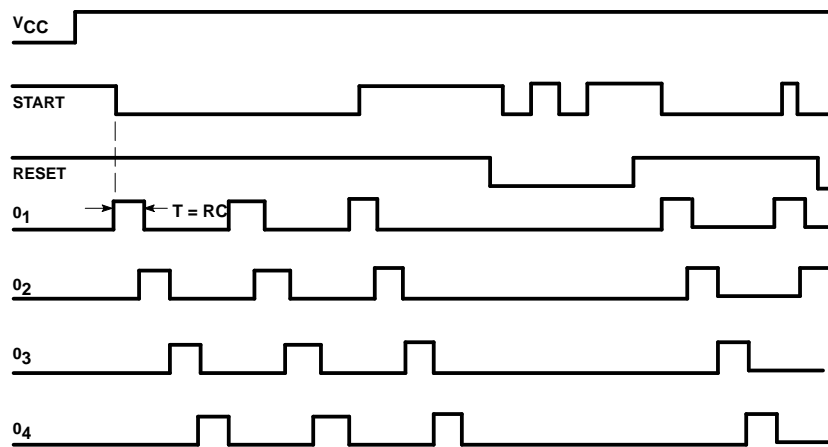

b. Expected Waveforms

Figure 2.