

DM74LS375 4-Bit Latch

General Description

The 'LS375 is a 4-bit D-type latch for use as temporary storage for binary information between processing units and input/output or indicator units. When its Enable (E) input is HIGH, a latch is transparent, i.e., the Q output will follow the

D input each time it changes. When E is LOW a latch stores the last valid data present on the D input preceding the HIGH-to-LOW transition of E. The 'LS375 is functionally identical to the 'LS75 except for the corner power pins.

Connection Diagram

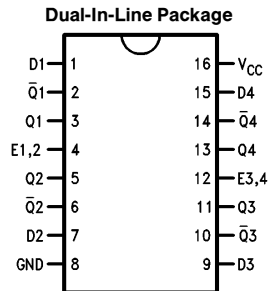

TL/F/9830-1

Logic Symbol

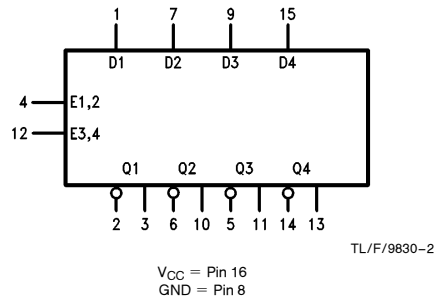

Order Number DM74LS375M or DM74LS375N
See NS Package Number M16A or N16E

Pin Name	Description
D1–D4	Data Inputs
E1, 2	Latches 1, 2 Enable Inputs
E3, 4	Latches 3, 4 Enable Inputs
Q1–Q4	Latch Outputs
$\bar{Q}1$ – $\bar{Q}4$	Complementary Latch Outputs

Absolute Maximum Ratings (Note)

Supply Voltage	7V
Input Voltage	7V
Operating Free Air Temperature Range	0°C to +70°C
Storage Temperature Range	-65°C to +150°C

Note: The "Absolute Maximum Ratings are those values beyond which the safety of the device cannot be guaranteed. The device should not be operated at these limits. The parametric values defined in the "Electrical Characteristics" table are not guaranteed at the absolute maximum ratings. The "Recommended Operating Conditions" table will define the conditions for actual device operation.

Recommended Operating Conditions

Symbol	Parameter	Min	Nom	Max	Units
V _{CC}	Supply Voltage	4.75	5	5.25	V
V _{IH}	High Level Input Voltage	2			V
V _{IL}	Low Level Input Voltage			0.8	V
I _{OH}	High Level Output Current			-0.4	mA
I _{OL}	Low Level Output Current			8	mA
T _A	Free Air Operating Temperature	0		70	°C
t _s (H) t _s (L)	Setup Time HIGH or LOW D _n to E _n	20			ns
t _h (H) t _h (L)	Hold Time HIGH or LOW D _n to E _n	0			ns
t _w (H)	E _n Pulse Width HIGH	20			ns

Electrical Characteristics

Over recommended operating free air temperature range (unless otherwise noted)

Symbol	Parameter	Conditions	Min	Typ (Note 1)	Max	Units
V _I	Input Clamp Voltage	V _{CC} = Min, I _I = -18 mA			-1.5	V
V _{OH}	High Level Output Voltage	V _{CC} = Min, I _{OH} = Max, V _{IL} = Max	2.7	3.4		V
V _{OL}	Low Level Output Voltage	V _{CC} = Min, I _{OL} = Max, V _{IH} = Min		0.35	0.5	V
		I _{OL} = 4 mA, V _{CC} = Min		0.25	0.4	
I _I	Input Current @ Max Input Voltage	V _{CC} = Max, V _I = 7V	Others		0.1	mA
			Enable Input		0.4	mA
I _{IH}	High Level Input Current	V _{CC} = Max, V _I = 2.7V	Others		20	μA
			Enable Input		80	μA
I _{IL}	Low Level Input Current	V _{CC} = Max, V _I = 0.4V	Others		-0.4	mA
			Enable Input		-1.2	mA
I _{OS}	Short Circuit Output Current	V _{CC} = Max (Note 2)	-20		-100	mA
I _{CC}	Supply Current	V _{CC} = Max			12	mA

Note 1: All typicals are at V_{CC} = 5V, T_A = 25°C.

Note 2: Not more than one output should be shorted at a time, and the duration should not exceed one second.

Switching Characteristics

$V_{CC} = +5.0V, T_A = +25^{\circ}C$

Symbol	Parameter	$C_L = 15\text{ pF}$		Units
		Min	Max	
t_{PLH} t_{PHL}	Propagation Delay D_n to Q_n		27 23	ns
t_{PLH} t_{PHL}	Propagation Delay D_n to \bar{Q}_n		20 15	ns
t_{PLH} t_{PHL}	Propagation Delay E_n to Q_n		27 25	ns
t_{PLH} t_{PHL}	Propagation Delay E_n to \bar{Q}_n		30 18	ns

Truth Table (Each Latch)

t_n	t_{n+1}
D	Q
H	H
L	L

t_n = Bit time before Enable negative going transition.
 t_{n+1} = Bit time after Enable negative going transition.
 H = HIGH Voltage Level
 L = LOW Voltage Level

Logic Diagram (1/4 of diagram shown)

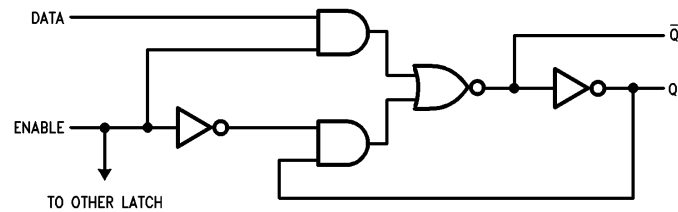

TL/F/9830-3



Physical Dimensions inches (millimeters)

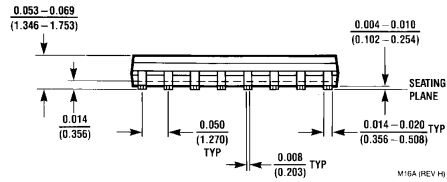
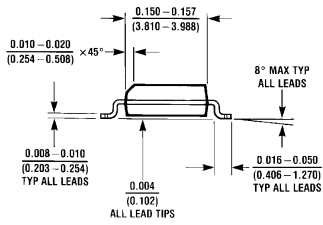
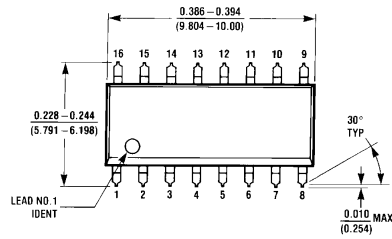

16-Lead Small Outline Molded Package (M)
Order Number DM74LS375M
NS Package Number M16A

Physical Dimensions inches (millimeters) (Continued)

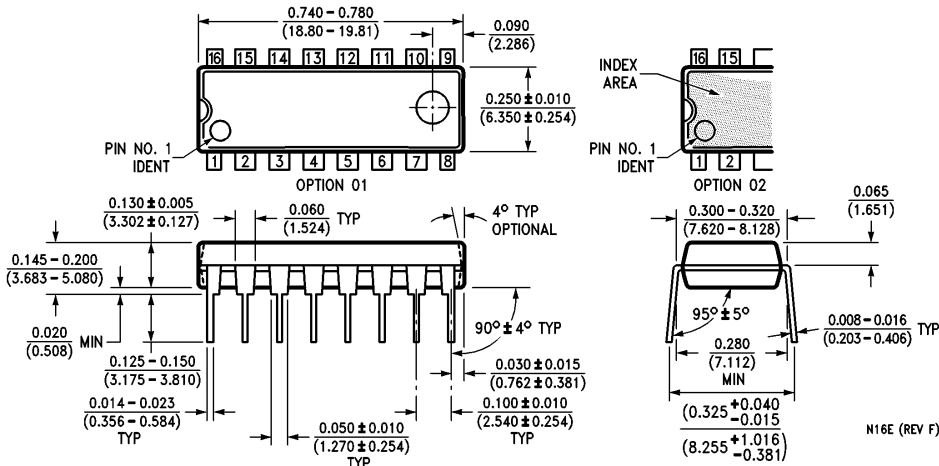

16-Lead Molded Dual-In-Line Package (N)
Order Number DM74LS375N
NS Package Number N16E

LIFE SUPPORT POLICY

NATIONAL'S PRODUCTS ARE NOT AUTHORIZED FOR USE AS CRITICAL COMPONENTS IN LIFE SUPPORT DEVICES OR SYSTEMS WITHOUT THE EXPRESS WRITTEN APPROVAL OF THE PRESIDENT OF NATIONAL SEMICONDUCTOR CORPORATION. As used herein:

1. Life support devices or systems are devices or systems which, (a) are intended for surgical implant into the body, or (b) support or sustain life, and whose failure to perform, when properly used in accordance with instructions for use provided in the labeling, can be reasonably expected to result in a significant injury to the user.
2. A critical component is any component of a life support device or system whose failure to perform can be reasonably expected to cause the failure of the life support device or system, or to affect its safety or effectiveness.



National Semiconductor Corporation
 1111 West Bardin Road
 Arlington, TX 76017
 Tel: 1(800) 272-9959
 Fax: 1(800) 737-7018

National Semiconductor Europe
 Fax: (+49) 0-180-530 85 86
 Email: cnjwge@tevm2.nsc.com
 Deutsch Tel: (+49) 0-180-530 85 85
 English Tel: (+49) 0-180-532 78 32
 Français Tel: (+49) 0-180-532 93 58
 Italiano Tel: (+49) 0-180-534 16 80

National Semiconductor Hong Kong Ltd.
 19th Floor, Straight Block,
 Ocean Centre, 5 Canton Rd.
 Tsimshatsui, Kowloon
 Hong Kong
 Tel: (852) 2737-1600
 Fax: (852) 2736-9960

National Semiconductor Japan Ltd.
 Tel: 81-043-299-2309
 Fax: 81-043-299-2408

National does not assume any responsibility for use of any circuitry described, no circuit patent licenses are implied and National reserves the right at any time without notice to change said circuitry and specifications.