

A MASTER'S GUIDE TO

# Container Securing



### **The Standard P&I Club**

The Standard P&I Club's loss prevention programme focuses on best practice to avert those claims that are avoidable and that often result from crew error or equipment failure. In its continuing commitment to safety at sea and the prevention of accidents, casualties and pollution, the Club issues a variety of publications on safety-related subjects, of which this is one. For more information about these publications, please contact either the Managers' London Agents or any Charles Taylor office listed in this guide.

## **The Standard**



#### *Authors*

**Eric Murdoch BSc, MSc, MRINA, C.Eng**  
Director of Risk Management  
Charles Taylor & Co Limited  
1 St Katharine's Way  
London E1W 1UT  
UK

Telephone (44) 20 7522 7440  
Email [eric.murdoch@ctcplc.com](mailto:eric.murdoch@ctcplc.com)  
[www.standard-club.com](http://www.standard-club.com)

The authors acknowledge technical contributions from colleagues and associates.

The authors express their particular thanks to:

**Bob Thompson, Principal Specialist, Lloyd's Register EMEA;**  
**Colin Clifford-Smith, Lead Specialist, Lloyd's Register EMEA;**  
**Tony Bowman, Managing Director, TMC (Marine Consultants) Ltd;**  
**Roy Smith, Safety Manager (Operations), Hutchison Ports (UK).**

Thanks also for assistance to:

**German Lashing Robert Bock GmbH;**  
**SEC - Ship's Equipment Centre Bremen GmbH;**  
**Mediterranean Shipping Company S.A;**  
**Maersk Line Limited;**  
**MacGregor (DEU) GmbH.**

### **The Lloyd's Register Group**

Lloyd's Register is directed through its constitution to: 'secure for the benefit of the community high technical standards of design, manufacture, construction, maintenance, operation and performance for the purpose of enhancing the safety of life and property both at sea and on land and in the air', and to advance 'public education within the transportation industries and any other engineering and technological disciplines'.



**David Tozer BSc, MSc, FRINA, C.Eng**  
Business Manager Container Ships  
Lloyd's Register  
71 Fenchurch Street  
London EC3M 4BS  
UK

Telephone (44) 20 7709 9166  
Email [david.tozer@lr.org](mailto:david.tozer@lr.org)  
[www.lr.org](http://www.lr.org)



# CONTENTS

- 2 Introduction**
- 3 Basic Advice**
- 4 Do's and Don'ts**
- 5 Lashing Systems**
- 7 Safe Working**
- 8 Ships and Containers**
- 13 Container Construction**
- 17 Lashing Components**
- 22 Principles of Stowage**
- 31 Ships' Behaviour**



# INTRODUCTION

The development of containerisation was a giant step forward in carrying general cargo by sea. At the time, it was correctly predicted that unit costs would fall and cargo damage become a thing of the past. This has been true until recently.

In the early days of containerised transport, ships carried containers stowed on hatch covers, three or four high. A variety of lashing systems were in use. However, the most reliable system consisted of stacking cones, twistlocks, lashing bars, bridge fittings and turnbuckles (bottle screws). These systems were effective in lashing containers carried on deck to the third tier.

Today, ships are bigger and a post-Panamax container ship will carry containers on deck stacked up to six, seven or eight tiers high. However, while the ships are able to carry containers stacked higher, the lashing systems are still only capable of lashing to the bottom of the third tier containers or the bottom of the fourth or fifth tier containers when a lashing bridge is fitted. Ship design has developed but container lashing systems have not.

A classification society will approve a ship for the carriage of containers. Regulations stipulate that the ship must carry a cargo-securing manual. This will contain instructions as to how cargo should be secured. However, approval of the arrangements in the manual will not necessarily mean that cargo-securing arrangements will withstand foul weather.

A ship sailing in a seaway has six degrees of freedom – roll, pitch, heave, yaw, sway and surge. The ship itself bends and twists as waves pass. Hatch covers can move relative to the hatch opening and a stack of containers can move as tolerances in lashing equipment are taken up. It is the lashing system alone that resists these movements and attempts to keep containers on board.

Lashing systems are only tested during bad weather; if they fail then containers may be lost. Indeed, the growing number of containers lost overboard has caused concern throughout the marine industry. Cargo claims have increased and floating containers pose a hazard to navigation. Ship masters need to understand the strengths and weaknesses of container securing systems. It is essential that masters be aware of what can be done to prevent container loss.

The purpose of this guide is to discuss container securing systems, the causes of lashing failure and to offer advice as to how losses can be minimised.

**Eric Murdoch**

IT IS ESSENTIAL THAT  
MASTERS BE AWARE OF  
WHAT CAN BE DONE TO  
PREVENT CONTAINER LOSS



# BASIC ADVICE

There are certain actions which should always be taken to prevent containers from being damaged or lost overboard. The following is considered best practice:

- Check stack weights before stowage. It is important not to exceed allowable stack weights otherwise failure of the corner posts of the containers stowed at the bottom of the stack is possible. If the stow is too heavy, the lashings may have insufficient strength to hold the containers in place if bad weather is encountered.
- Never deviate from the approved lashing plan except to add additional lashings. Calculate forces using the approved loading computer.
- Consult the lashing manual before applying lashings.
- If stack weights are high and bad weather is expected then fit additional lashings.
- Try to avoid isolated stacks of containers when stowed on deck, especially if at the ship's side. Where possible, load containers so they are evenly distributed.
- Avoid loading heavy containers above light containers and at the top of a stack.
- Keep your system of lashing simple using the highest rated components.
- Examine containers for physical defects – check the corner posts carefully. The corner posts have to resist high compression forces as a result of static weights from containers stowed on top and from dynamic forces that occur when the ship rolls, heaves and pitches. Containers with damaged corner posts placed in the bottom of a stow are likely to collapse. Reject damaged containers.
- Check that all cell guides are clear of obstacles, are straight and not buckled.
- Check that turnbuckles are fully tightened. Loose lashings will be ineffective.
- Check lashing equipment for defects and discard worn or damaged equipment. Avoid using left-hand and right-hand twistlocks on the same ship.
- Regularly examine lashing components, including ship fittings, for wear. Replace any worn or damaged fitting, repair any worn or damaged ship fitting. Check all equipment not just equipment in regular use.
- It is difficult to know when lashing components should be replaced. Few organisations are confident to issue 'criteria for replacement' which means that the company or individual master will need to exercise judgement. If in doubt, replace the equipment. Give special attention to dovetail or sliding socket foundations.
- To assist the shore lashing gang, give them precise instructions as to how containers should be secured.
- Remember that during ship rolling, forces on container corner posts can be up to three times greater than the upright compression force. Weather route in an attempt to avoid the worst of the meteorological systems or areas where high seas in winter are common.
- Try to avoid loading 'high cube' containers on deck in the first or second tier. Lashing rods are more difficult to fit and special rods with extension pieces are often needed. Identify where 'high cube' containers are to be stowed before loading. It may be necessary to reposition them.



# DO'S AND DON'TS

## ALWAYS:

- Reject a container found overweight and likely to give rise to the permissible stack weight being exceeded;
- Reject a buckled, twisted or damaged container;
- Arrange stowage so that containers do not need to be unloaded at a port other than the designated discharge port;
- Regularly check lashing components for condition and discard components that appear worn or are damaged;
- Inspect D rings, ring bolts, cell guides and sliding socket foundations for wear or damage before containers are loaded, and arrange for the necessary repairs;
- Regularly check lashings during the voyage;
- Inspect and tighten lashings before the onset of bad weather;
- Take care when handling container fittings because they are heavy. Avoid dropping them;
- Stow loose lashing components, twistlocks and lashing rods safely in designated baskets or racks;
- Buy components that are supported by a test certificate. The strength of equipment without a test certificate may be unpredictable;
- Have more securing equipment than necessary;
- Avoid extreme values of GM, whether high or low;
- Avoid geographical areas where conditions for parametric rolling exist;
- Look for indications of water leakage into the container.

## NEVER:

- Mix left-hand and right-hand twistlocks;
- Apply fully automatic twistlocks without first checking the manufacturer's instructions for use;
- Use corroded or buckled lashing rods;
- Use twistlocks that are not certified;
- Use improvised equipment to secure containers;
- Load containers of a non-standard length except when the ship is designed and equipped for the carriage of non-standard length containers;
- Use twistlocks for lifting containers except where the twistlocks are specifically approved for this purpose;
- Open containers after they have been loaded;
- Connect reefer containers to damaged or broken electrical sockets;
- Load containers in a con-bulker that requires fitting a buttress, unless the buttress is already fitted;
- Drop or throw fittings, especially twistlocks, from a great height onto a steel deck or other hard surface;
- Lash to the top of a container; always lash to the bottom of the next tier above wherever possible;
- Work dangerously with containers. Never stand or climb onto them, or under or between them.

# LASHING SYSTEMS

## Common False Beliefs

P&I club investigations into container loss indicate that the loss often occurs because an apparent weakness has not been identified. The following points are worth noting:

- ***Once containers have been loaded and secured, the stow remains in a tight block and does not move – False***

Twistlock and sliding socket clearances will allow containers to move before the twistlocks engage. The clearance will permit movement of the stow. Wear inside the corner fitting can cause additional movement.

- ***Containers can be stowed in any order and/or combination/mix of weights – False***

The most common mistake made when stowing and lashing containers is to load heavy containers over light and to load so that the maximum permissible stack weights are exceeded.

- ***Lashings applied from a lashing bridge behave in the same manner as those applied at the base of a stow – False***

A lashing bridge is a fixed structure while a hatch cover will move when a ship rolls and pitches. The resulting effect could be that a lashing from a lashing bridge becomes slack or takes excessive load.

- ***Containers loaded on a pedestal and a hatch cover do not suffer additional loading – False***

A hatch cover is designed to move as the ship bends and flexes. A container stowed on a pedestal, a fixed point, will attempt to resist hatch cover movement if also secured to a hatch cover.

- ***Lashing rods should be tightened as tight as possible – False***

In theory, excessive tightening of lashing rods will result in the rods taking additional strain, which can cause rod failure during loading.

- ***It is not necessary to adjust the tension in lashings while at sea – False***

Movement of containers will result in some lashing rods becoming slack. Air temperature differences will cause the tension in the lashings to change. Lashings should be checked and tightened within 24 hours after leaving port and regularly thereafter. This is especially true before the onset of bad weather.

- ***Container strength is equal throughout the container – False***

Although strength standards are met, a container is more flexible at the door end and may be more vulnerable in this area.

- ***All twistlocks can be used to lift containers – False***

Twistlocks can be used for lifting containers only when they have been approved and certified for that purpose.

- ***Twistlocks are all rated to the same strength – False***

Twistlocks can be rated for different tensile loads up to 20 or 25 tonnes. It is important not to use a mix of twistlocks that have different strength ratings.

- ***All containers have the same strength – False***

Container strength can vary. There are two ISO standards (pre- and post-1990). Some owners have their own standards and containers can be worn or damaged.



# LASHING SYSTEMS

## Common False Beliefs continued

- ***Horizontal lashings to lashing bridges are an alternative to vertical cross lashings – False***

Crossed horizontal lashings from lashing bridges will hold a container. However, the container will be held rigidly to the fixed lashing bridge. When a ship bends and twists, the base of a container attached to a hatch cover will move, but container ends held firmly to a lashing bridge with horizontal lashings will not move. The effect will be to put strain on the lashings and even break the bars or damage the container corner castings.

Horizontal lashings should not be used unless specifically permitted in the approved lashing plan.

- ***Parametric rolling will not occur on ships with a high GM – False***

Parametric rolling occurs because of the fine hull form of large post-Panamax container ships. The large bow flare and wide transom increases the effect. The phenomenon occurs because of changes in the waterplane area, which can cause large changes in GM as waves pass. At times, GM can become negative. A large initial GM will provide large righting levers that can lead to violent rolling.

- ***Provided stack weights have not been exceeded, the distribution of containers in a stack on deck is not important – False***

It is essential to avoid loading heavy containers over light, and at the top of a stack in a deck stow. This is because the securing system would have been designed on the assumption that light containers are stowed on top. If stowage allows for 'heavy', 'heavy', 'light', then loading 'heavy', 'medium', 'medium', will place different strains on the securing system, even if the stack weight is the same.





# SAFE WORKING

## Working With Containers

The decks, hatch covers and holds of a container ship can be extremely dangerous places to work. To avoid accidental injury, exercise care and follow these rules:

- When working on deck, always wear high visibility clothing, safety shoes and a hard hat.
- Never allow fittings to be thrown onto the ship's deck from a height.
- Check that sliding sockets and stacking cones are removed from hatch covers before opening.
- When working in the vicinity of moving containers, never work with your back towards a container or stand where a swinging container could strike you.
- Never stand under a raised container.
- When working on the top or side of a container, use safe access equipment and never climb containers.
- If working from a ladder, secure the ladder properly and wear a safety harness. Attach the line from the harness to a secure point.
- Take care climbing onto a lashing bridge. There could be loose items of equipment that can fall or the safety bar could be across the opening.
- Tidy loose equipment that is lying on decks, hatch covers and coamings. These are trip hazards.
- Never climb up the side of a stack of containers. Use an access cradle.
- Take care when fixing penguin hooks or lashing rods as these can slip and strike someone.
- Close access gratings after passing through. They are there to protect you.





# SHIPS AND CONTAINERS

A ship is only designated as a container ship when it is designed exclusively for the carriage of containers. Other ship types that carry containers as part of a mixed cargo are often categorised as 'suitable for the carriage of containers in holds *xxxx,...*'.

P&I clubs provide cover for the carriage of containers on deck only when the ship is especially designed, fitted or adapted for the

trade. This means that hatch covers and container landing points are approved for the particular stack weight and the lashing system satisfies classification society design criteria.

Containers can be carried on many ship types – cellular container ships, con-bulkers, bulk carriers and general cargo ships. The following is a brief description of the ships and their features.

## Ship Types

### Container Ships

- Designed exclusively for the carriage of containers.
- Containers in holds are secured by cell guides.
- Containers on deck are secured by portable lashing components, often rods and twistlocks.



### Container Ships – Hatchcoverless

- Designed exclusively for the carriage of containers.
- No hatch covers.
- Bridge may be located fully forward to provide protection.
- If the bridge is not sited forward, it is common for the forward two or three holds to be fitted with hatch covers, especially if dangerous goods are to be carried.
- All containers are secured in cell guides.





# SHIPS AND CONTAINERS

## Con-Bulkers

- A ship with hold arrangements suitable for the carriage of both containers and bulk cargoes.
- Various configurations, including:
  - Bulk cargoes carried in designated holds, containers in other holds;
  - Containers carried above bulk cargo;
  - Containers carried only on deck.



## Ro-Ro Cargo Ships

- Various configurations, including:
  - Ro-Ro cargo aft and containers in conventional holds forward;
  - Containers loaded by fork lift trucks in Ro-Ro decks;
  - Containers on deck and Ro-Ro cargo in the Ro-Ro deck.



## General Cargo Ships

- Containers in holds, secured by traditional wire lashings.
- Containers on deck secured by container-securing equipment.
- Containers may be carried athwartships. Only possible when cargo is carefully stowed within the container.
- Containers loaded on dunnage and carried as general cargo.



## Ships' Structure

The combined weight of a stack of containers may amount to a total downward force on the tank top, through each container corner casting, of up to 100 tonnes. Where four container corners are placed close together, such as at the mid-hold position when carrying 20-foot containers, the total local load on the tank top may be four times this.

During classification, the strength of the ship's structure to support containers is verified and approved. This includes assessment of

the strength of the tank top, the cell guides and, on deck, the strength of the hatch covers, lashing bridges, pedestals and the fixed fittings associated with the container stow.

It is important to carry containers within the loading conditions imposed by the classification society. Container loads should never exceed the permitted stack weights as set down in the ship's loading manual.



# SHIPS AND CONTAINERS

## Container Sizes

Containers are standardised cargo units. They are manufactured in a large variety of sizes and types, each designed to meet specific cargo and transportation requirements. Their length is usually 20 or 40 feet, although longer containers are used, principally in the US trade; these containers are 45, 48 and 53 feet long. Their width is always 8 feet although their height can vary. The term 'high cube' container usually refers to a standard-sized container that has a height of 9 feet 6 inches. Container heights can be 8 feet, 8 feet 6 inches, 9 feet 6 inches or 10 feet 6 inches.

The ISO standard for containers defines dimensions, both internal and external, and load ratings. All containers have a framework and corner posts fitted with corner castings. The castings at each corner of the container support the container's weight.

The castings are the only points at which a container should be supported, and are used to attach securing fittings, such as lashing rods and twistlocks. The position and spacing of corner castings are carefully controlled.

Containers that are longer than 40 feet usually have additional support points at the 40-foot position so that they can be stowed over a standard 40-foot container. Standard sizes for ISO Series 1 freight containers include those shown in the table below.

20-foot containers are actually a little shorter than 20 feet, so that two 20-foot containers can be stowed in a 40-foot bay. The actual dimensions are 12192mm for a 40-foot container and 6058mm for a 20-foot container. Thus, two 20-foot containers are 76mm shorter than a 40-foot container.

**Standard Sizes for ISO Series 1 Freight Containers**

DESIGNATION	LENGTH	WIDTH	HEIGHT
1AAA			<b>9'6"</b>
<b>1AA</b>	<b>All at 40'0"</b>	<b>All at 8'0"</b>	<b>8'6"</b>
1A			8'0"
1AX			<8'0"
1BBB			9'6"
<b>1BB</b>	<b>All at 30'0"</b>	<b>All at 8'0"</b>	<b>8'6"</b>
1B			8'0"
1BX			<8'0"
1CCC			8'6"
<b>1C</b>	<b>All at 20'0"</b>	<b>All at 8'0"</b>	<b>8'0"</b>
1CX			<8'0"
<b>1D</b>	<b>All at 10'0"</b>	<b>All at 8'0"</b>	<b>8'0"</b>
1DX			<8'0"

APPROXIMATE DIMENSIONS, IN FEET AND INCHES. MOST COMMON SIZES HIGHLIGHTED.  
SUFFIX 'X' MEANS THE CONTAINER HEIGHT IS LESS THAN 8 FEET.

# SHIPS AND CONTAINERS

## Container Types

There are a number of types of container in common use. They all have basically the same frame, and the differences relate to what they can be used for and access.

### Dry Van Boxes

- The most common type.
- They have corrugated steel walls, timber base, steel or glass reinforced plastic (GRP) top.
- Corrugated walls can be made from plate from as little as 1.6mm (1/16 inch) in thickness.
- Their frame consists of side and end rails and corner pillars, fitted with corner castings.
- The closed end is approximately 4.5 times more stiff, in racking strength, than the door end.

### Curtain wall containers

- Curtain wall containers are similar to dry van boxes, but have fabric side walls that can be opened to facilitate easy cargo handling.

### Refrigerated Containers

- General construction as for dry van boxes.
- They usually have their own refrigeration unit, with an air or a water-cooled heat exchanger.
- A small number of CONAIR boxes use close-coupled ventilation.
- They have their own data logger to record temperature.



# SHIPS AND CONTAINERS

## Tank Containers

- Steel skeletal framework within which the tank is housed.
- Steel framework must have equivalent strength to a dry van box.
- The tank has its own design and strength criteria and it may be a pressure vessel.



## Flat-rack Containers

- The container frame can be folded flat for ease of transportation when empty.
- The structure must have equivalent strength to a dry van box.
- P&I cover may not extend to cargoes carried on deck in a flat-rack container.





# CONTAINER CONSTRUCTION

## Construction and Strength

The strength of a container is provided principally by the outer framework, side rails and corner posts, together with the corner castings. The side and end panels provide racking strength.

- Corner Posts

Effective stacking of containers relies on the strength of the corner posts to support the weight of the containers above. Damage to a corner post, in particular buckling, can seriously degrade its compressive strength and lead to collapse of a container stack.

- The Outer Frame

Horizontal forces on the container, such as those caused by roll and pitch motions, are resisted by the shear strength of the container. This is provided by the frame and also by the plate walls. Of course, soft-walled containers rely totally on the shear strength of the frame.

- Corner Castings

A container's corner castings hold twistlocks or stacking cones when containers are connected to each other or to the ship's deck/hold. Lashing rods attach to corner castings and, during lifting, a spreader bar.

While compressive loads can be carried by the direct contact between the containers, tensile and shear loads are resisted by the loose fittings. It is important for the corner castings to be in good condition if the fittings are to work effectively and perform their intended function.

The position of corner fittings must be carefully controlled during the manufacture of containers to ensure that they fit together properly and to ensure that the fittings work effectively.

- Forklift Pockets

Not so common today, these can be cut into the bottom side rail and are used when the containers are lifted by a forklift truck. Forklift pockets are a discontinuity in the side rail that could weaken the container if contact damage occurs.

It is important to note a container that has suffered damage to a corner casting or end pillar will not be serviceable because:

- a damaged container may be unable to bear the weight of those stowed above;
- a damaged container may render lashings ineffective;
- a damaged container is dangerous to lift.

If one container in a stack fails, it is likely that the entire stack will collapse.

IF ONE CONTAINER IN A STACK FAILS, IT IS LIKELY THAT THE ENTIRE STACK WILL COLLAPSE



# CONTAINER CONSTRUCTION

## Container Certification

New designs of container are prototype tested to ensure that they have sufficient strength. If tests prove satisfactory, then the container design may be certified by a classification society.

Certification is then issued by the classification society for containers of similar design, constructed by production methods and quality control procedures that are agreed and verified by survey. Changes in the method of construction may nullify the certification, unless the changes are approved by the classification society.

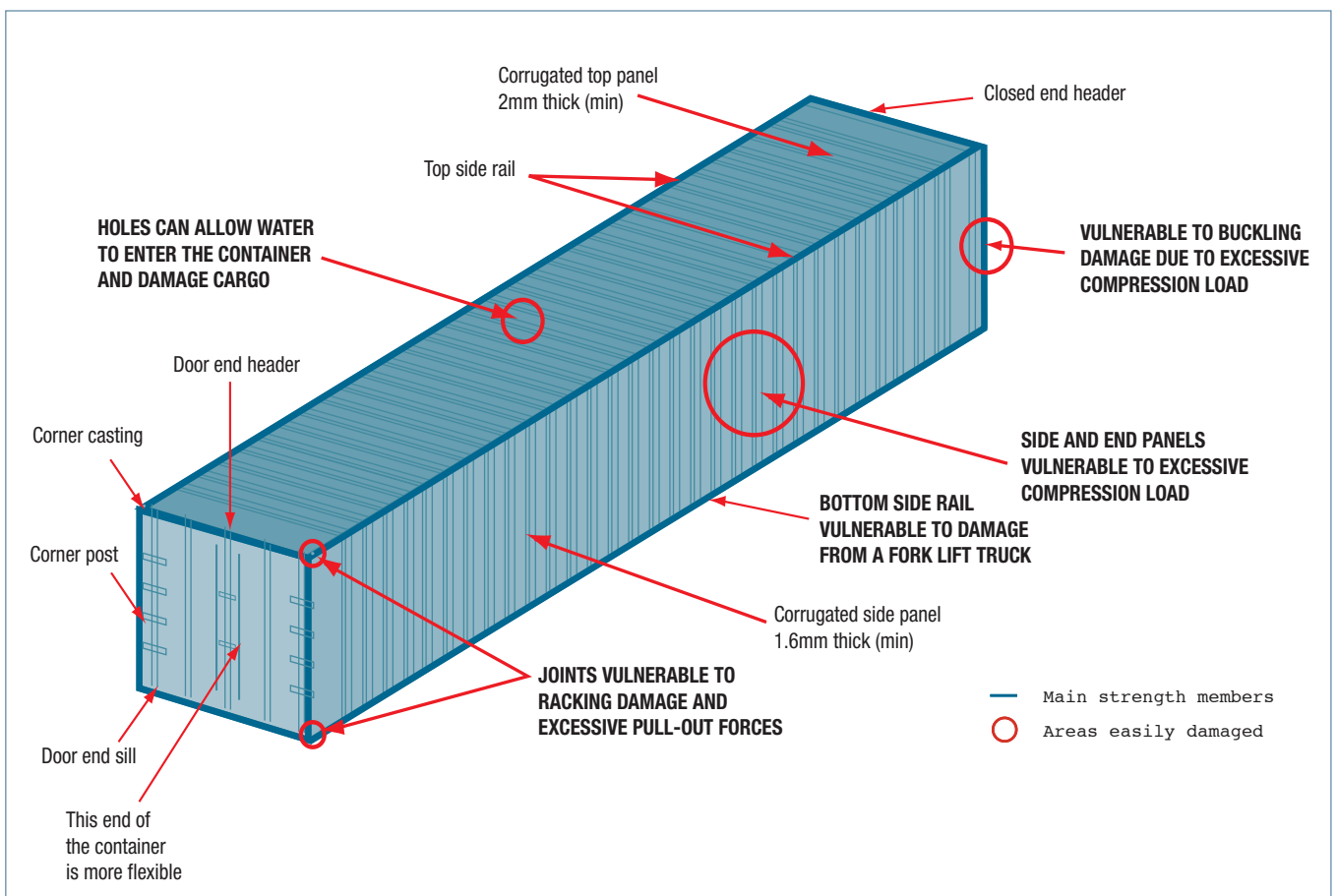



# CONTAINER CONSTRUCTION

The Lloyd's Register Certification Scheme covers three general categories of container:

- ISO Series 1 Containers – all types, including: dry van boxes, reefer containers, open top containers, non-pressurised dry bulk containers, platform based containers and tank containers.
- Swap Body Containers.
- Offshore Containers.

The scheme ensures that each container complies with the appropriate ISO standard, covering, for example:

- dimensions.
- strength of walls, floor and roof.
- strength of corner posts.
- rigidity (longitudinal and transverse).
- weathertightness.
- number of other features as appropriate to the type of container, such as strength of forklift pockets.

When containers are strength-tested it is important to remember that they are not tested for tandem lifting and that the corner posts are only tested for compressive strength. In addition, it is only the top corner fittings that are tested for lifting; the bottom fittings are never tested.

A container that has satisfactorily passed the Lloyd's Register container certification scheme will bear the LR logo.

## ISO Series 1 – Freight Containers

The primary documents for the design of ISO Series 1 containers are:

ISO 668 Series 1: Freight Containers, Classification Dimensions and Ratings

ISO 1161 Series 1: Freight Containers, Corner Fittings, Specification

ISO 1496 Series 1: Freight Containers, Specification and Testing.

ISO 1496-2:1996 : Series 1: Freight Containers - Specification and Testing. Part 2: Thermal Containers

ISO 1496-2:1996/Amd.1:2006 : Series 1: Freight Containers, Specification and Testing. Part 2: Thermal Containers. Amendment 1.

## Ship Classification

The ship classification process ensures that the ship's hull, hatch covers, lashing bridges, cell guides and fixed fittings have sufficient strength. Loose fittings such as container securing components may be excluded from this certification process. Although a classification society may assess the adequacy of loose fittings and assign a class notation, this examination is additional to the ship classification process. P&I clubs provide cover for the carriage of containers that generally require the ship to be approved for the carriage of containers by a classification society and the container securing arrangements to at least meet the classification society design requirements.



# CONTAINER CONSTRUCTION







## Certification of Reefer Containers

The ability of a reefer container to maintain a given temperature when using its integral refrigeration unit is tested in accordance with ISO 1496-2. This consists of two tests, one to determine the heat loss through the envelope of the container, and the other to ensure the refrigeration unit can operate with a specific internal load. These tests are arranged during type approval. The amount of electrical power required to maintain a reefer container at a given temperature depends on the size of the container (TEU or FEU), the required cargo temperature, the cargo being carried and the ambient air temperature. For example, 9kW of electricity is needed to maintain a temperature of  $-18^{\circ}\text{C}$  in a 40-foot container carrying frozen meat, while a container carrying fruit at  $2^{\circ}\text{C}$  requires approximately 11kW. Certain cargoes, for example bananas, may require even more power. There is a high electrical load on ship's generators when reefer containers are carried.

# LASHING COMPONENTS

There are a variety of lashing components available to secure containers, the majority of which are listed below. For some time, P&I clubs have recommended the use of a system based on

twistlocks, lashing rods, turnbuckles and lashing plates. The table below shows the locations where components are commonly used.

<b>Fixed Fittings (attached to ship)</b>			
<b>DESCRIPTION</b>	<b>PURPOSE</b>	<b>IMAGE</b>	<b>NOTES</b>
Flush Socket	Locating of base twistlocks or stacking cones in the cargo hold.		Normally fitted over a small recess to ensure watertightness. Clean and remove debris before use.
Raised Socket	Locating of base twistlocks or stacking cones on deck.		Clean and remove debris before use.
Lashing Plate or 'Pad-eye'	Tie down point for turnbuckle on deck or hatchcover.		Designed only for in-plane loading. An out-of-plane load could bend the plate and may crack the connecting weld.
D Ring	Alternative tie down point for a turnbuckle.		Corrosion of the pin ends can weaken a D Ring. Suitable for in-plane and out-of-plane loading.
Dovetail Foundation	Base for sliding twistlock.		Clean before use. Check for damage or wear.
Fixed Stacking Cone	To prevent horizontal movement of 20-foot containers in 40-foot cell guides.		Often found at the base of a cell guide.
Mid-bay Guide	To prevent transverse movement of 20-foot containers in 40-foot guides. Fitted at tank top level.		Does not interfere with general stowage of 40-foot containers





# LASHING COMPONENTS

## Loose Fittings

Loose fittings are those that are not permanently attached to the ship. Loose fittings must be certified. However, they are **not** normally surveyed by the class society surveyor during regular ship

surveys. When using loose fittings, it is essential the manufacturer's instructions are followed at all times, especially when using fully automatic and semi-automatic twistlocks.





### Loose Fittings in Common Use

DESCRIPTION	PURPOSE	IMAGE	NOTES
Lashing Rod	To provide support for container stacks on deck. Used in conjunction with a turnbuckle.		Resists tensile loads. Very long lashing bars can be difficult to handle and difficult to locate in a container corner casting. They can have eyes at each end.
Extension Piece	To extend a lashing rod when securing 'high cube' containers.		Fit at the base of a lashing rod and connect to the turnbuckle.
Turnbuckle (Bottle screw)	To connect a lashing rod to a lashing plate or D ring. Tightening puts tension into a lashing rod.		Resists tensile loads and is used to keep the lashing tight. Regularly grease its threads. Ensure the locking nut or tab is locked.
Penguin Hook	Used as a supporting device in conjunction with a special lashing rod with an eye-end.		Likely to be put in place when container on shore because of difficulty in fitting when on board. Risk of injury if it falls out when container is lifted onboard.



## LASHING COMPONENTS





### Loose Fittings in Common Use

DESCRIPTION	PURPOSE	IMAGE	NOTES
Stacking Cone	Placed between containers in a stack and slots into corner castings.		Resists horizontal forces. Many types exist. May be locked into bottom corner castings prior to lifting a container on board.
Twistlock	Placed between containers in a stack and slots into corner castings.		As above but also resists separation forces. Each fitting requires locking after fitting. Left and right-hand types exist, causing uncertainty whether a fitting is locked or open.
Semi-automatic Twistlock	Placed between containers in a stack and slots into corner castings.		As above. Can be fitted on shore and automatically locks into the lower container when placed on top. It is easier to determine whether it is locked or not when compared to manual twistlocks. Unlocked manually.
Fully automatic Twistlock	Placed between containers in a stack and slots into corner castings.		A new and innovative design. Automatic unlocking during lifting. Usually opened by a vertical lift, with a twist/tilt.
Sliding Twistlock	To connect bottom containers to the ship.		Fits into a dovetail foundation. Used on hatch covers and in holds when a raised socket can cause an obstruction.



## LASHING COMPONENTS

### Loose Fittings Less Commonly Used

DESCRIPTION	PURPOSE	IMAGE	NOTES
Bridge Fitting	To link top containers of two adjacent stacks together. Can be used on deck or in a hold.		Resists tensile and compressive forces. Potential fall hazard for stevedores during placement.
Mid-Lock	Placed between containers in a stack, and slots into corner castings. Used on deck between 20-foot containers in 40-foot bays at mid-bay position.		Resists lateral and separation forces. Fitted to underside of container on shore and automatically locks into lower container when placed on board.
Buttress	External support for container stacks in a hold.		Can resist compressive and tensile forces. Must be used in conjunction with higher strength double stacking cones or link plates and aligned with side support structure.
Double Stacking Cone	To link adjacent stacks, particularly those in line with buttresses.		Resists horizontal forces. More commonly used on con-bulkers below deck.
Load Equalising Device	To balance the load between two paired lashings.		Enables two connections to two containers with both lashing rods being fully effective. Can only be used with designated lashing rods.

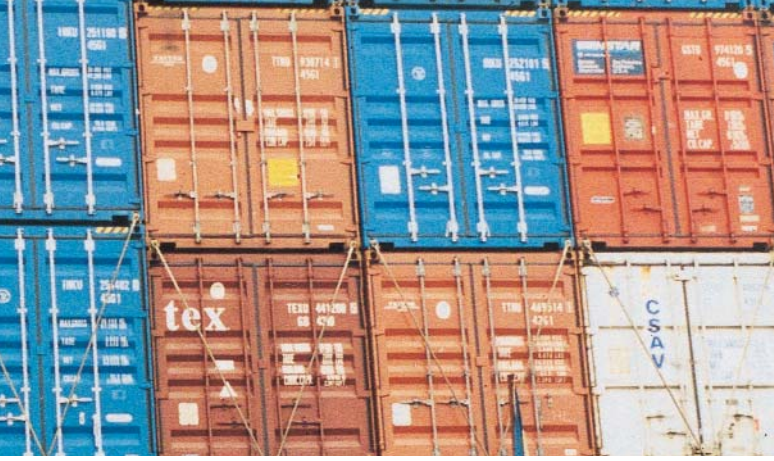

## LASHING COMPONENTS

- 1 Twistlock
- 2 Turnbuckle
- 3 Lashing Rod
- 4 Single Raised Socket
- 5 Double Raised Socket
- 6 Lashing Plate

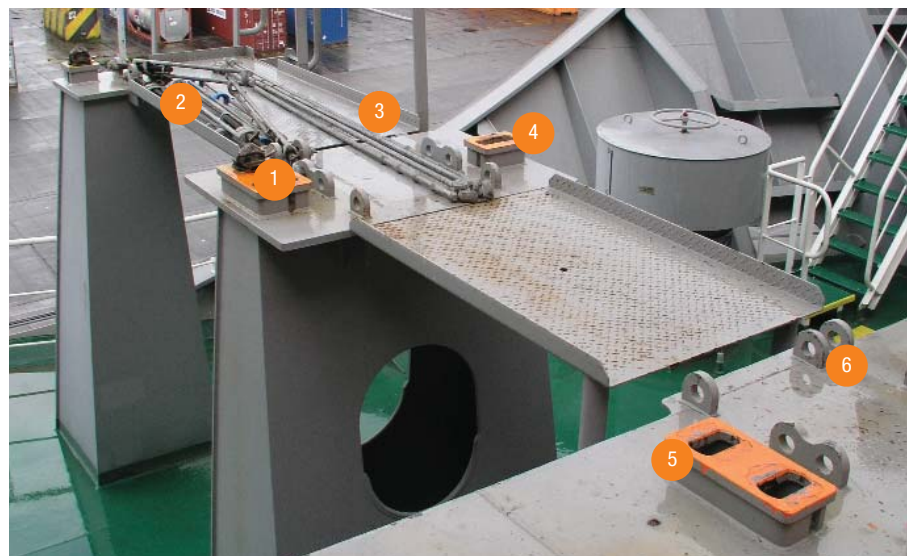

- 1 D Rings
- 2 Dovetail Foundation
- 3 Turnbuckle





# PRINCIPLES OF STOWAGE

Containers are rectangular box-shaped units of cargo. It is easy to stow them in classical block stowage both on and below deck.

When containers are carried on deck, the ship is required to be approved for that purpose and the containers themselves are secured with twistlocks and lashings. These usually consist of steel rods and turnbuckles.

When containers are carried below deck, the containers are slotted into cell guides on a cellular container ship, or sit on the tank top, joined together with stacking cones, in the holds of a dry cargo ship. Containers can easily be stowed in box-shaped holds; it is more difficult to carry them in the holds of a dry cargo ship fitted with side hopper tanks, in which case buttresses may be fitted.

When carried within a cell guide framework, no further external support is generally required. When 20-foot containers are stowed below deck in 40-foot cell guides it may be necessary to overstow the 20-foot containers with a 40-foot container. The container securing manual should be consulted before loading.

Containers carried on deck may be secured by twistlocks alone provided the stack is not more than two containers high. When containers are carried three high, twistlocks alone may be sufficient depending on the weight of the containers.

Horizontal movement of a deck stow is resisted by the twistlocks or cones. Lifting of containers, in extreme seas, is prevented by the pull-out strength of the twistlocks. The limitation of a twistlock only stow is often the racking strength of the containers. For stows of more than three containers high, lashing rods are fitted because they provide additional racking strength.

In the early days of containerisation, lashings were fitted vertically to resist tipping. However, it soon became clear that it is more effective to arrange the lashings diagonally, so that the container and the lashings work together to resist racking.

The usual arrangement is to fit one tier of lashings, placed diagonally within the width of the container with the tops of the lashing rods placed in the bottom corner castings of the second-tier containers.

To enable the fitting of twistlocks, a twistlock is designed with a vertical and horizontal gap between it and a container's corner casting. This becomes important when considering how lashings behave during ship roll, pitch and heave. Lashing rods are always fitted tight and kept tight by adjusting the turnbuckle. When force is transmitted to securing equipment during ship rolling, it is the lashing rods that bear the force first. It is only after the stack of containers has deflected and the gap at the twistlock 'taken up' that twistlocks become tight. For this reason, it is important to only use lashing rods that are in good condition and to apply them correctly.



## PRINCIPLES OF STOWAGE

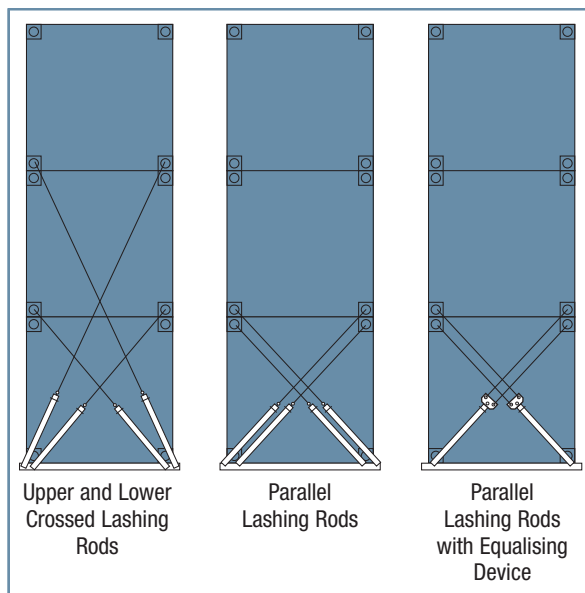

A second pair of lashings may be fitted, reaching to the bottom of the third tier of containers, as shown in the diagram opposite.

If additional lashing strength is required, parallel lashings may be used. With this arrangement, lashings are arranged in parallel, one fitted to the top of the first tier and one to the bottom of the second tier. The effectiveness of parallel lashings is taken as 1.5 times that of a single lashing, unless a load-equalising device is fitted, in which case it is twice.

For ease of loading and discharge, bridge fittings that link adjacent stacks of containers together are not commonly fitted. However since the force distribution and the response of adjacent container stacks will be similar, there is, in general, negligible load transfer between the stacks when linked together.

Bridge fittings tend to only be used on isolated, adjacent stacks of containers or when containers are loaded in the holds of a dry cargo ship.

The ship's approved cargo-securing manual contains information on how to stow and secure containers, and on any strength or stack weight limitation.

The most common mistakes made are to exceed the permissible stack weight, to incorrectly apply lashings and to place heavy containers in the top of a stow.

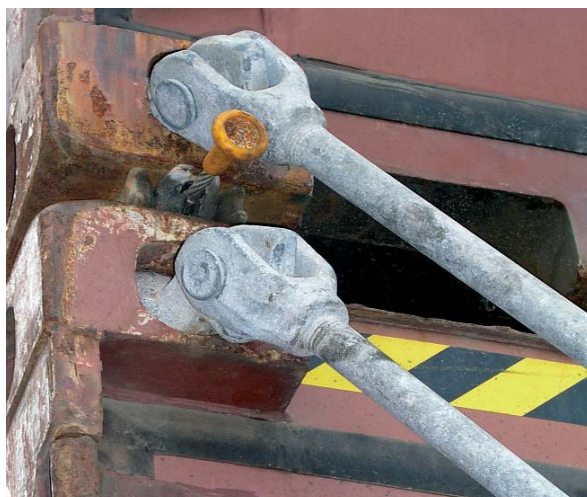

**SECURING WITH PARALLEL LASHING RODS AND SEMI-AUTOMATIC TWISTLOCK**

# PRINCIPLES OF STOWAGE

## Containers Carried Below Deck in Cell Guides

The cargo holds of most container ships are designed for the carriage of 40-foot containers, with the containers held in place by cell guides. The cell guides are generally steel angle bars orientated vertically with entry guides at the top to assist with locating the container – the clearances, and hence construction tolerances, are very tight.

The cell guides provide adequate longitudinal and transverse support to the 40-foot containers and no further securing arrangements are necessary. The lowest container in each stack sits on a pad which is supported by stiffened structure below the tank top.

20-foot containers may be stowed in 40-foot bays. This arrangement requires longitudinal and transverse support for the containers where they meet at the mid-length position. This is achieved by mid-bay guides at the tank top, placing stacking cones between tiers of containers and possibly overstowing the 20-foot containers with a 40-foot container.

Before loading containers in cell guides it is important to make sure that the guides are not bent or deformed.

## Containers Carried Below Deck Without Cell Guides

Containers are generally stowed in the fore and aft direction, with the containers secured using locking devices only or by a combination of locking devices, buttresses, shores or lashings. The aim is to restrain the containers at their corners. Twistlocks are very good at preventing corner separation.

When carrying containers in the hold of a bulk carrier or general cargo ship, base containers are secured with twistlocks or cones. Buttresses should be fitted to provide lateral support, and a platform, with sockets for cones or twistlocks, may be fitted in the forward and after holds. This forms the basis for block stowage of containers when combined with cones, twistlocks and bridge fittings.

Various designs of portable buttress are available.

Aim for a tight block when loading containers below deck on a con-bulker. During loading, check to make sure that means are applied to ensure that the lowest tier does not slide horizontally when the ship rolls.



# PRINCIPLES OF STOWAGE

## Typical Arrangements for Containers Stowed Below Deck

### 40-FOOT CONTAINERS IN 40-FOOT CELL GUIDES

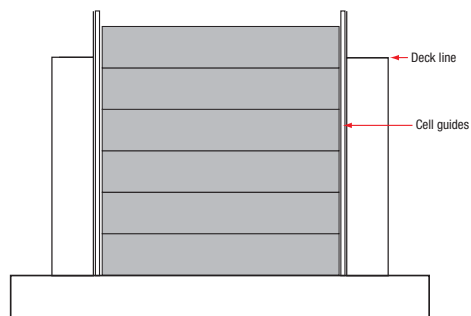
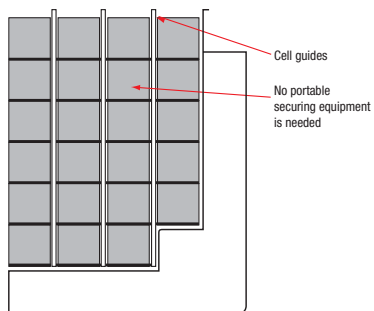

### 20-FOOT CONTAINERS IN 40-FOOT CELL GUIDES

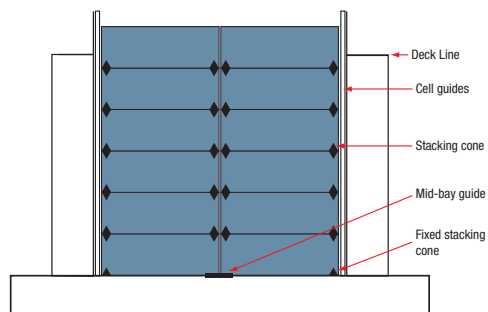
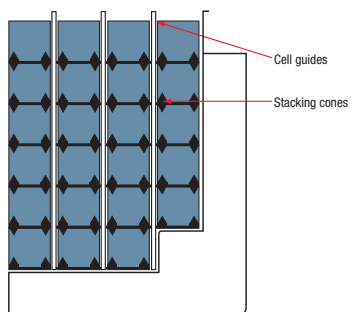

# PRINCIPLES OF STOWAGE

## 20-FOOT CONTAINERS IN 40-FOOT CELL GUIDES WITH 40-FOOT CONTAINERS STOWED ABOVE

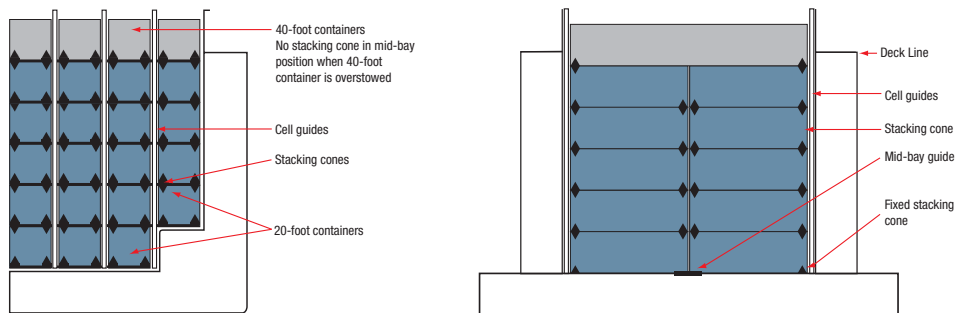

## TYPICAL BULK CARRIER STOWAGE ARRANGEMENT WITH BUTTRESSES, USING SINGLE/DOUBLE STACKING CONES AND BRIDGE FITTINGS

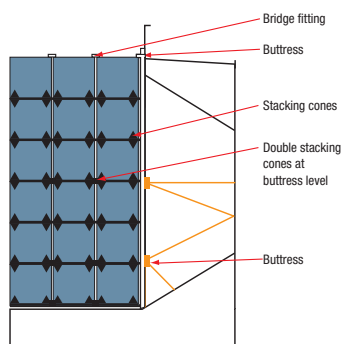

### Containers Carried on Deck

Containers are usually stowed longitudinally in vertical stacks.

Containers within each stack are fastened together with twistlocks. The bottom corners of each base container are locked to the deck, hatch cover or pedestal with a twistlock. When stacked in multiple tiers, the containers are usually lashed to the ship's structure by diagonal lashing rods.

The lashing rods are usually applied to the bottom corners of second or third-tier containers. On ships fitted with a lashing bridge, the lashing rods may be applied to the bottom corners of fourth or fifth-tier containers.

Lashings are applied so that each container stack is secured independently. In theory, the loss of one stack should not affect its neighbour.

Transverse stowage, although possible, is uncommon, mainly because cargo could move or fall out of the container when the ship rolls, but also because transverse stowage requires rotation of the spreader bar of the shore gantry crane.

In some cases, containers are carried on deck in cell guides, in which case, the principles on page 24 apply. The same principles also apply to hatchcoverless container ships.

# PRINCIPLES OF STOWAGE

## Typical Arrangements for Containers Carried on Deck

**CONTAINERS SECURED BY TWISTLOCKS. Usually for two tiers only.**

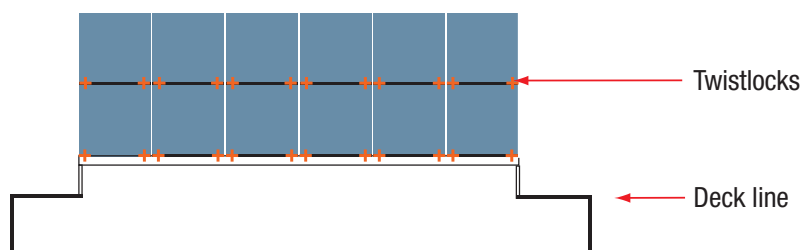

**CONTAINERS SECURED BY TWISTLOCKS AND LASHING RODS. Lashing rods to bottom of second tier. Wind lashings to bottom of third tier.**

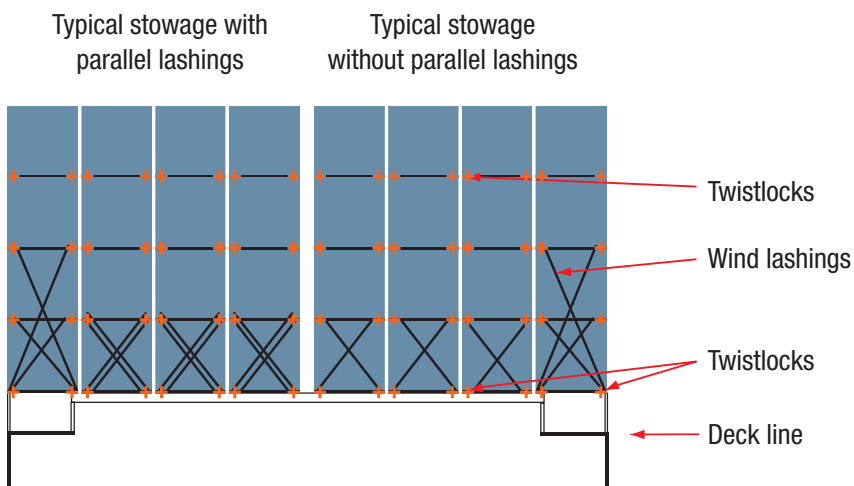

# PRINCIPLES OF STOWAGE

**CONTAINERS SECURED BY TWISTLOCKS AND LASHING RODS. Lashing rods to bottom of third tier.**

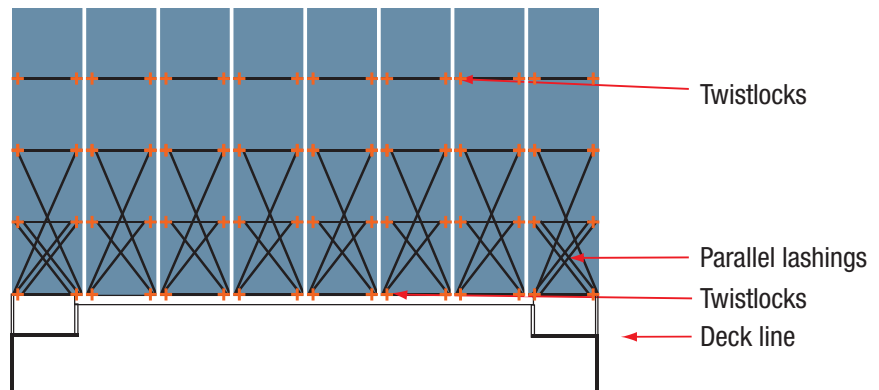

**AS ABOVE BUT LASHINGS ORIGINATE FROM A LASHING BRIDGE. Lashing rods to bottom of fifth tier.**

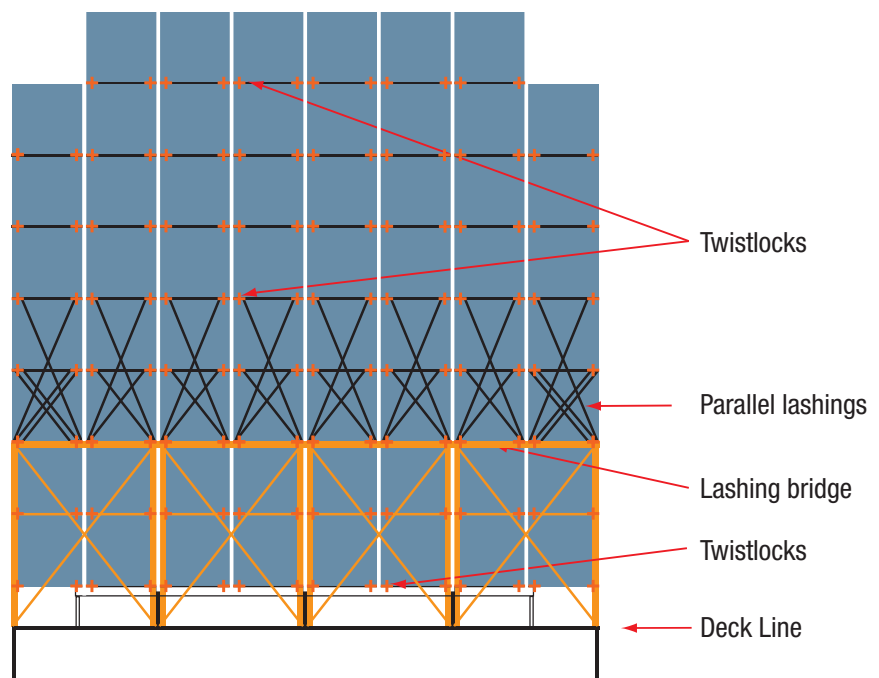



## PRINCIPLES OF STOWAGE

### WHEN STOWING AND SECURING CONTAINERS, THE FOLLOWING POINTS SHOULD BE BORNE IN MIND:

- A deck stack of containers is only as strong as the weakest component in that stack. Premature failure of a component can cause loss of an entire stack. During loading, containers should be inspected for damage and, if damaged, they should be rejected.
- Twistlocks limit vertical and transverse movement. Diagonal crossed lashing rods, placed at the ends of a container, can withstand large tensile loads.
- Outside lashings are sometimes used. These are lashings that lead away from a container. However, although this arrangement provides a more rigid stow than a combination of crossed lashings and twistlocks, it is generally not as practical or strong and is not commonly used.
- Containers exposed to wind loading need additional or stronger lashings. When carried in block stowage, it is the outer stacks that are exposed to wind loading. However, when carried on a partially loaded deck, isolated stacks and inboard containers can also be exposed to wind, in which case additional lashings need to be applied.
- If containers of non-standard length, i.e. 48 or 53-feet, are carried, the ship arrangement will need to be specially adapted.
- 45-foot containers fitted with additional corner posts at 40-foot spacing can be stowed on top of 40-foot containers. Lashings can be applied in the normal way.
- 40-foot containers may be stowed on top of 45-foot containers. However, this arrangement of stowage will present difficulties in fastening/unfastening twistlocks, and it will not be possible to apply lashings to the 40-foot containers.
- Twistlocks should always be locked, even when the ship is at anchor, except during container loading and unloading. Lashing rods should be kept taut and, where possible have even tension. Lashing rods should never be loose nor should they be over-tightened. Turnbuckle locking nuts should be fully tightened.
- As a ship rolls, pitches and heaves in a seaway, tension, compression and racking forces are transmitted through the container frames, lashings and twistlocks to the ship's structure. However, clearances between securing components and the elasticity of the container frame and lashing equipment produce a securing system that forms a flexible structure. Thus, a deck stow of containers will move.
- Containers can be held by only twistlocks when two or three tiers are carried on deck, depending upon container weights.
- Arrangements with automatic and semi-automatic twistlocks are used to reduce time spent securing the stow.

# PRINCIPLES OF STOWAGE

## CHECKS AND TESTS DURING DISCHARGE AND LOADING

- Regularly examine lashing components, looking for wear and tear, damage or distortion. Check that left-hand and right-hand locking twistlocks are not being mixed in the same storage bin. Remove from the ship any lashing component found to be worn, damaged or distorted.
- Make arrangements for some damaged or distorted lashing components to be sent for non-destructive testing. This will determine their strength and help to establish replacement criteria.
- Carefully check twistlocks that stevedores return to the ship as the locks might not originate from your ship; their strength and locking direction could differ.
- Discourage stevedores from treating lashing equipment roughly as this can induce weakness.
- Examine dovetail foundations, D rings and pad-eyes for damage. Repair if damage is found.
- Observe the loading of containers to determine if stowage is in accordance with the stowage plan and that best practice is always followed.
- Observe the application of lashings to make sure that they are correctly applied in accordance with the requirements set out in the cargo-securing manual.

## CHECKS AND TESTS AT SEA

- 24 hours after sailing, examine, check and tighten turnbuckles. Check that lashings are applied in accordance with the cargo securing manual and that twistlocks have been locked.
- Examine lashings every week. Check that they have not become loose and tighten turnbuckles as necessary.
- Before the onset of bad weather, examine lashings thoroughly and tighten turnbuckles, being careful to keep an equal tension in individual lashing rods. If necessary, apply additional lashing rods to the outboard stacks and to stacks with 20-foot containers in 40-foot bays.
- Recheck lashings after passing through bad weather.
- Make sure that lashing equipment that is not in use is correctly stored in baskets or racks.
- Make an inventory of lashing equipment and order spares before they are needed.
- Check that refrigerated boxes remain connected to the ship's power supply.





# SHIPS' BEHAVIOUR

Container ships, due to the nature of their trade, are required to keep to very tight operating schedules. Maintaining the schedule is an important part of the liner trade. As a result, these ships have powerful engines, not only to provide the high speeds required, but also to enable speed to be maintained during bad weather.

The consequence is that, at times, container ships can be driven hard. When ships are driven hard in bad weather, the loads on the lashings can be severe.

There are many load components arising from a ship's motion. These will be discussed below.

## Container Strength and Ship Motion

Although a ship has six degrees of freedom, it is only roll, pitch and heave that are taken into account during the calculation of forces on a container stow. Surge is important for road and rail transportation and containers are designed with this in mind.

The motion of a ship in irregular seas is itself irregular and is impossible to accurately predict. Consequently, when calculating accelerations on a stack of containers, regular cyclic response is assumed in association with an assumed maximum amplitude. Empirical formulae for maximum amplitude and period of response are defined in the Rules and Regulations for the Classification of Ships published by Lloyd's Register. Rolling motion is dominant in the calculation of forces and a roll amplitude of 22 to 30 degrees is generally used.

For calculation purposes, the forces acting on a container may be resolved into components acting parallel to, and normal to, the vertical axis of the container stack. Gravity acts vertically downwards and, therefore, when the stack is inclined at maximum roll or pitch, there are force components of static weight acting both parallel to, and normal to, the vertical axis of the stack. The dynamic components of force are vectors. These are combined algebraically with the static components.

Wind is assumed to act athwartships and to affect only the exposed stacks on the windward side of the ship. The magnitude of wind force, for a wind speed of 78 knots, is about 2 tonnes on the side of a 20-foot container and about 4 tonnes on a 40-foot. The vertical component of wind on the top of the uppermost inclined container is ignored.

The assessment of the effect of green seas on exposed container stacks is by necessity empirical. The general principle is to require the container securing arrangement in the forward quarter of the ship to be suitable for forces increased by 20%, except when the ship has an effective breakwater or similar.

Calculations of forces acting on a container assume three combinations of the individual components of motion. These are:

- **Rolling.** Roll and heave acting together.
- **Pitching.** Pitch and heave acting together.
- **Combined.** Roll and pitch acting together. In this condition, it is assumed that the roll angle and the pitch angle are each 0.71 times the calculated maximum angle of roll and pitch respectively.

Within each of these three conditions, it is necessary to define the instantaneous positions in the cycle of motion at which the calculations are made.

There are four limiting positions within each cycle which, for the rolling condition, are:

- Bottom of roll – bottom of heave.
- Top of roll – bottom of heave.
- Bottom of roll – top of heave.
- Top of roll – top of heave.

Of course, in an actual seaway, all components of motion act simultaneously to a greater or lesser extent.

# SHIPS' BEHAVIOUR

Lloyd's Register Rules allowable forces on an ISO container (ISO 1496-1:1990)

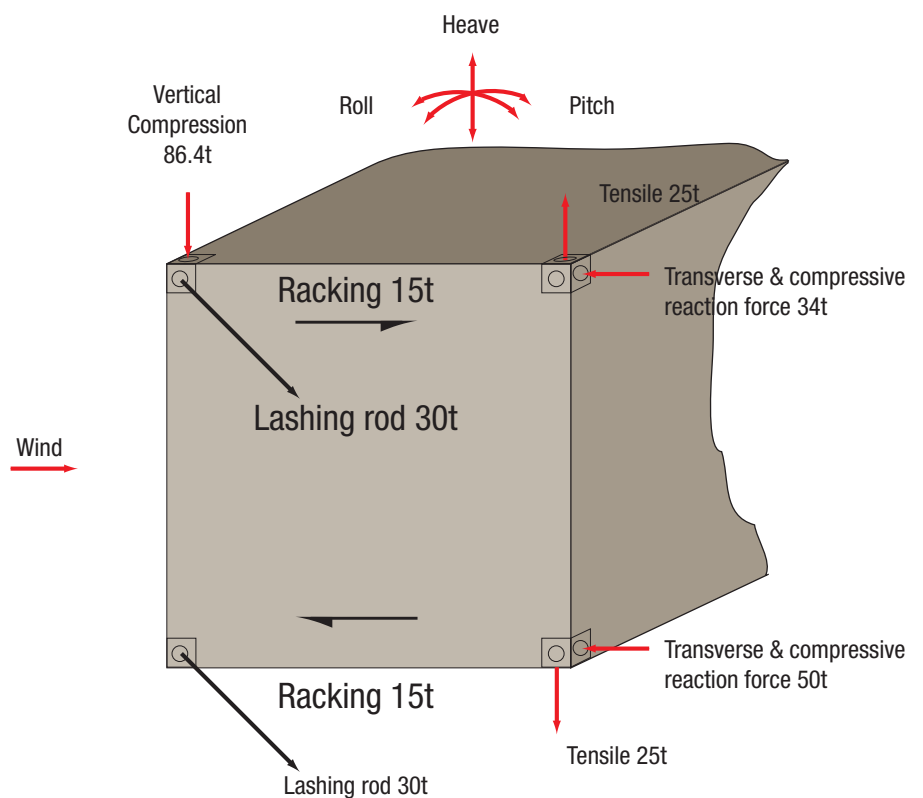

The calculation of the forces in the lashing arrangements is thus a very complex matter. This is further exacerbated by the deflections of the hull, for example:

- The cross-deck structure may move by as much as 50mm as the containers surge forward and aft.
- As the ship makes its way through a head or stern quartering sea, the hull twists, distorting the hatch openings.

## Parametric Rolling

The term parametric roll is used to describe the phenomenon of large, unstable rolling, which can suddenly occur in head or stern quartering seas. Due to its violent nature and the very large accelerations associated with the onset of parametric rolling, there is widespread concern for the safety of container ships. Possible consequences include loss of containers, machinery failure,

structural damage, and even capsizing.

Parametric roll is a threshold phenomenon. This means that a combination of environmental, operational and design parameters need to exist before it is encountered. These are:

- The ship would be travelling with a small heading angle to the predominant wave direction (head or stern quartering sea).
- Wavelength of the predominant swell would be comparable to ship's length.
- Wave height would be fairly large.
- The ship's roll-damping characteristic would be low.

If resonance occurs between the wave encounter period and the natural, or twice natural, roll period of the ship, then parametric roll motion can be experienced.

# SHIPS' BEHAVIOUR

- **WHY ARE LARGE CONTAINER SHIPS VULNERABLE?**

Fine hull forms with pronounced bow flare and flat transom stern are most vulnerable to parametric roll.

Such features contribute to the variation of the ship's stability characteristics due to the constant change of the underwater hull geometry as waves travel past the ship.

Although this phenomenon has been studied in the past, it has only come to prominence with the introduction of the larger ships. Until the 1990s, it was considered critical only for ships with marginal stability and fine-lined warships.

- **CONSEQUENCES OF A PARAMETRIC ROLL**

A parametric roll can have dire consequences for container securing and for operation of machinery.

It is an extreme condition for container securing since it combines the effect of large roll and pitch amplitudes. This scenario imposes significant loads on container securing systems.

In theory the container securing system could be designed to withstand such extreme motions. The consequence would be a significant reduction in the number of containers that could be carried on deck. So, essentially, there is a balance between increased container security and limitations imposed by securing requirements.

The extreme roll angles reached during a parametric roll usually exceed those adopted during machinery design. Indeed, it would be very difficult to bench test a large marine diesel engine at 40-degree angles. Possible consequences on machinery operation of the ship heeling to these very large angles include loss of cooling water suction, exposure of lubricating oil sumps and, for resiliently mounted engines, problems with connection of services – and hence shutdown of the main engine.

The following points should be borne in mind:

- Parametric roll is a relatively rare phenomenon occurring in head or following seas, which is characterised by rapidly developed, large, unstable ship rolling.
- Risk control options exist in both design and operation of container ships that can effectively reduce the likelihood of a parametric roll occurring.
- Reducing the likelihood of its occurrence is considered a more effective approach than mitigating the consequences.
- Compliance with Lloyd's Register current requirements for container securing systems reduces the risk of container losses.
- Masters should be aware that, when conditions for parametric rolling exist, the action of putting the ship's head to the sea and reducing speed could make rolling worse.
- The North Pacific in winter is known to be an area where conditions for parametric rolling exist.

FURTHER INFORMATION CAN BE OBTAINED FROM CHARLES TAYLOR, THE STANDARD CLUB'S MANAGERS OR THEIR PRINCIPAL OFFICES AROUND THE WORLD, OR FROM LLOYD'S REGISTER AT THE FOLLOWING ADDRESSES:

## CHARLES TAYLOR P&I OFFICES

### UK (London)

Charles Taylor & Co. Limited  
International House  
1 St. Katharine's Way  
London E1W 1UT  
England

Telephone (44) 20 7488 3494  
Emergency mobile (44) 7932 113573  
Facsimile (44) 20 7481 9545  
E-mail [p&i.london@ctcplc.com](mailto:p&i.london@ctcplc.com)

### Greece(Piraeus)

Charles Taylor & Co. Limited  
c/o Richards Hogg Lindley (Hellas) Ltd.  
85 Akti Miaouli  
Piraeus 185 38  
Greece

Telephone (30) 210 429 0733  
Emergency mobile (30) 6944 761 147  
Facsimile (30) 210 429 0818  
E-mail [p&i.piraeus@ctcplc.com](mailto:p&i.piraeus@ctcplc.com)

### Australia(Sydney)

Charles Taylor P&I Management  
(Australia)  
Level 10  
8 Spring Street  
Sydney  
NSW 2000 Australia

Telephone (61) 2 9252 1599  
Facsimile (61) 2 9252 9070  
E-mail [p&i.sydney@ctcplc.com](mailto:p&i.sydney@ctcplc.com)

### Singapore

Charles Taylor Mutual Management  
(Asia) Pte. Limited  
140 Cecil Street  
10-02 PIL Building  
Singapore 069540

Telephone (65) 6221 1060  
Facsimile (65) 6221 1082  
E-mail [p&i.singapore@ctcplc.com](mailto:p&i.singapore@ctcplc.com)

### Japan(Tokyo)

Charles Taylor Consulting  
(Japan) Ltd.  
3/Fl., Parkside 7 Bldg  
2-10-12 Kanda Tsukasa-Cho  
Chiyoda-Ku,  
Tokyo 101-0048

Telephone (81) 3 3255 8640  
Facsimile (81) 3 3255 8642  
E-mail [p&i.tokyo@ctcplc.com](mailto:p&i.tokyo@ctcplc.com)

### Bermuda (Hamilton)

Charles Taylor & Co. (Bermuda)  
Limited  
Dallas Building  
7 Victoria Street  
Hamilton  
Bermuda  
PO Box 1743 HMGX

Telephone (1) 441 292 7655  
Facsimile (1) 441 292 8992  
E-mail [p&i.bermuda@ctcplc.com](mailto:p&i.bermuda@ctcplc.com)  
Telex 3343 BA

### USA (New York)

Charles Taylor P&I Management  
40 Exchange Place,  
New York  
NY 10005-2701

Telephone (1) 212 809 8085  
Emergency mobile (1) 646 321 2146  
Facsimile (1) 212 968 1978  
E-mail [p&i.newyork@ctcplc.com](mailto:p&i.newyork@ctcplc.com)

# LLOYD'S REGISTER

## Europe, Middle East and Africa

Lloyd's Register EMEA  
71 Fenchurch Street  
London EC3M 4BS

Telephone: (44) 20 7709 9166  
Facsimile: (44) 20 7488 4796  
Email: [emea@lr.org](mailto:emea@lr.org)

## Americas

Lloyd's Register Americas, Inc.  
1401 Enclave Parkway Suite 200  
Houston, TX  
77077 USA

Telephone: (1) 281 675 3100  
Facsimile: (1) 281 675 3139  
Email: [americas@lr.org](mailto:americas@lr.org)

## Asia

Lloyd's Register Asia  
Suite 3501 China Merchants Tower  
Shun Tak Centre, 168-200 Connaught Road  
Central Hong Kong, SAR of PRC

Telephone: (852) 2287 9333  
Facsimile: (852) 2526 2921  
Email: [asia@lr.org](mailto:asia@lr.org)

# NOTICE AND TERMS OF USE

## NOTICE AND TERMS OF USE

All rights reserved. No part of this publication may be reproduced, stored in a retrieval system, or transmitted in any form or by any means, electronic, mechanical, photocopying, recorded or otherwise, without the prior permission of the publisher and copyright owner.

While the principles discussed and the details given in this book are the product of careful study, the authors and the publisher cannot in any way guarantee the suitability of recommendations made in this book for individual problems, and they shall not be under any legal liability of any kind in respect of, or arising out of, the form or contents of this book or any error therein, or in the reliance of any person thereon.

Neither the Standard P&I Club, its managers or Lloyd's Register nor any of their officers, employees or agents shall be responsible or liable in negligence or otherwise howsoever in respect of any inaccuracy or omission herein.

Without derogating from the generality of the foregoing, the Standard P&I Club, Lloyd's Register nor any of their officers, employees or agents shall be liable for any indirect or consequential loss caused by or arising from any information, advice or inaccuracy or omission herein.

Services are provided by members of the Lloyd's Register Group. Lloyd's Register, Lloyd's Register EMEA and Lloyd's Register Asia are exempt charities under the UK Charities Act 1993.

A Master's Guide to Container Securing is jointly published by Lloyd's Register and the Standard P&I Club, by the Managers' London Agents, Charles Taylor & Co Limited, International House, 1 St Katharine's Way, London E1W 1UT.  
Telephone (44) 20 7488 3494, Fax (44) 20 7481 9545, Email p&i@london@ctcplc.com  
Charles Taylor & Co Limited is a Charles Taylor Consulting company.

[www.standard-club.com](http://www.standard-club.com)

The information and commentary herein are not intended to amount to legal or technical advice to any person in general or about a specific case. Every effort is made to make them accurate and up to date. However, no responsibility is assumed for their accuracy nor for the views or opinions expressed, nor for any consequence of or reliance on them. You are advised to seek specific legal or technical advice from your usual advisers about any specific matter.

**CTC**  
CHARLES TAYLOR  
CONSULTING