

FRONT VIEW

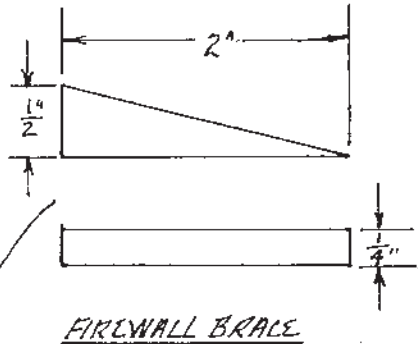

FIREWALL BRACE

FAIRLEAD LOCATED  $6\frac{1}{2}$ "  
OUT FROM FUSELAGE

TWO SPRINGS REQUIRED FOR EACH  
WHEEL TO KEEP THEM ON AXEL  
SECURE SPRINGS TO AXEL WITH  
A DROP OF SUPER GLUE

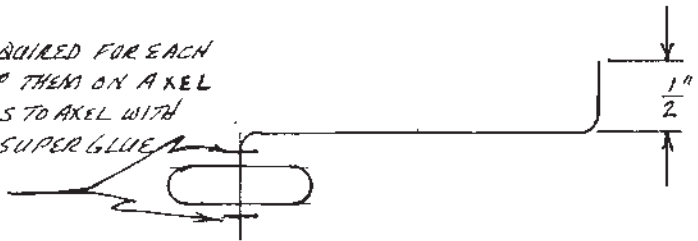

LANDING GEAR WIRE

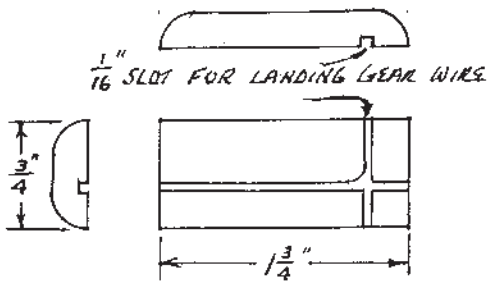

APPLY GLUE TO BOTH WIRE  
STRUT & SUPPORT - THEN  
CLAMP BOTH TO WING TO DRY

LANDING GEAR SUPPORT

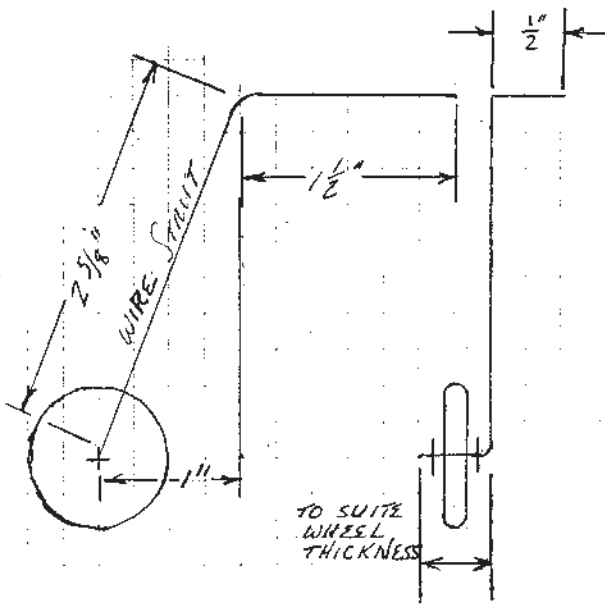

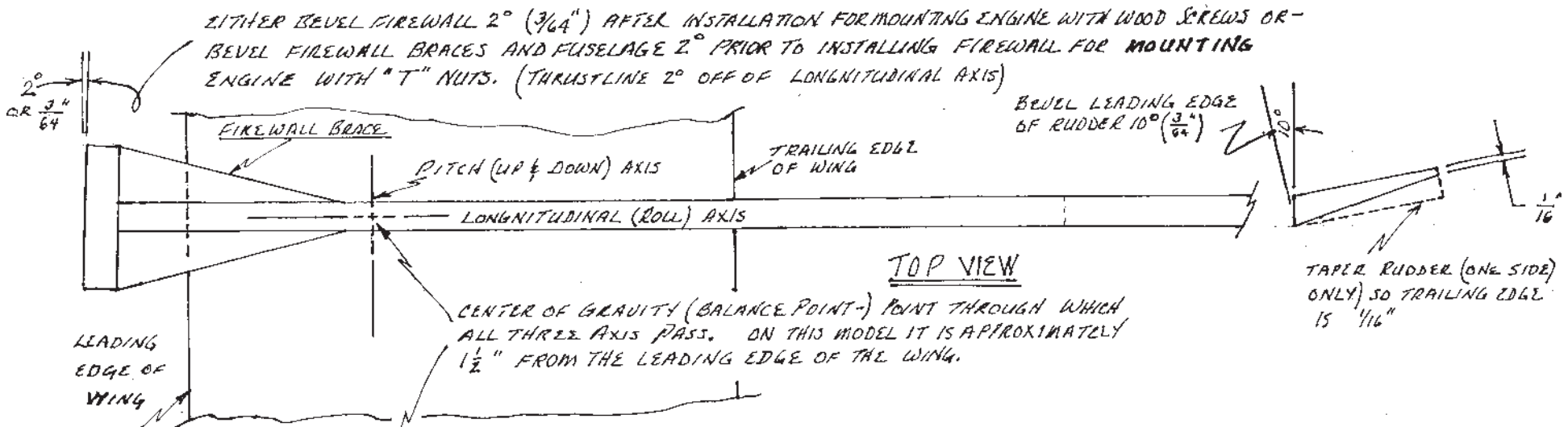

TAPER RUDDER (ONE SIDE ONLY) SO TRAILING EDGE IS  $\frac{1}{16}$ "

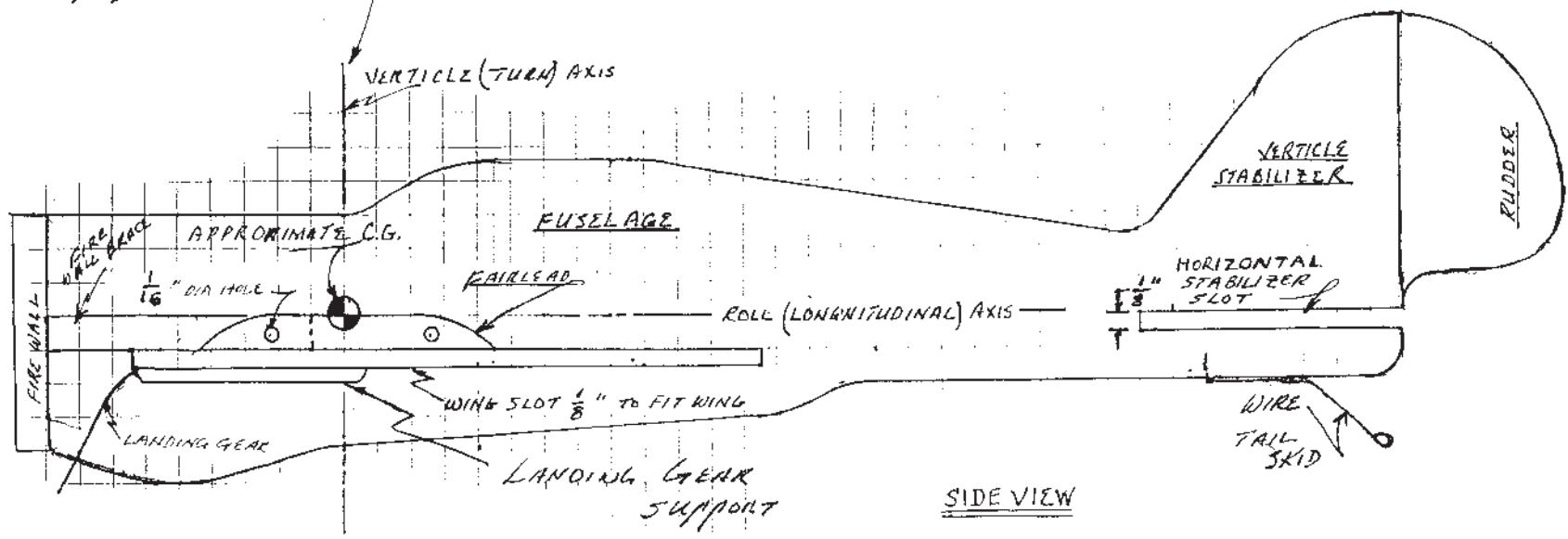

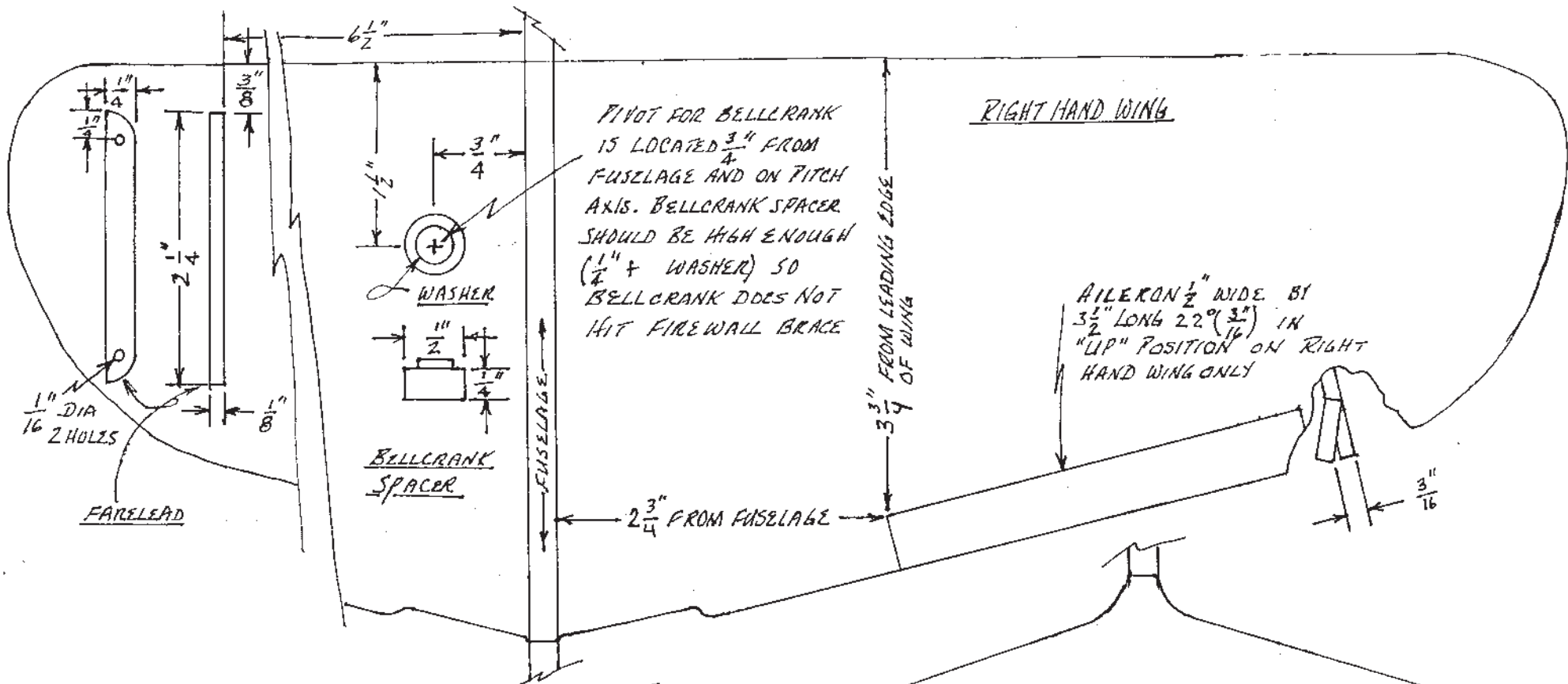

GLUE ONE HINGE TAPE TO TOP OF HORIZONTAL STABILIZER AND BOTTOM OF ELEVATOR. GLUE OTHER HINGE TAPE TO BOTTOM OF HORIZONTAL STABILIZER AND TOP OF ELEVATOR. KEEP GAP AS SMALL AS POSSIBLE.

